

WINAM GROUP PARKOUR

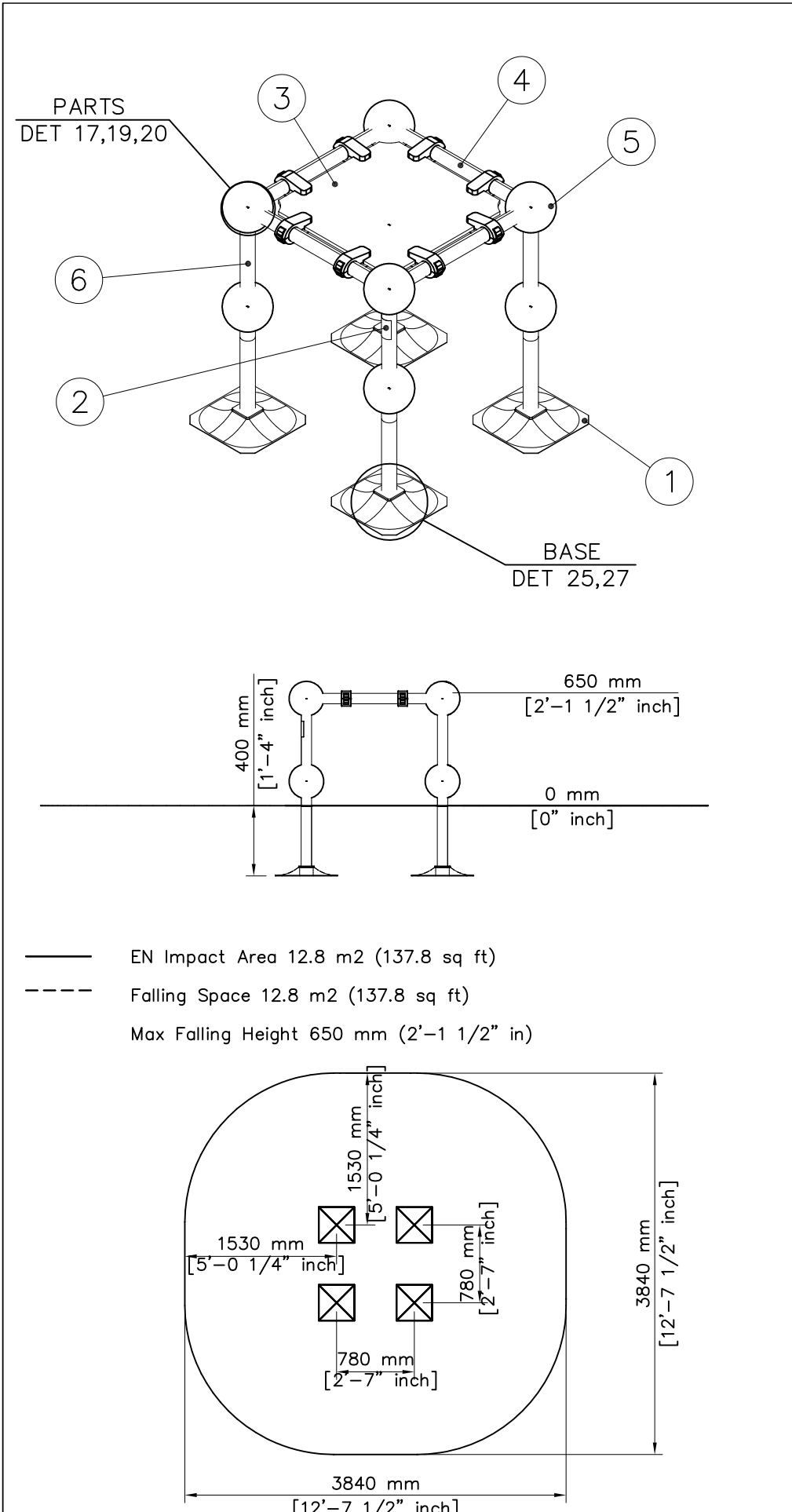

220503

DATE: 20.2.2015

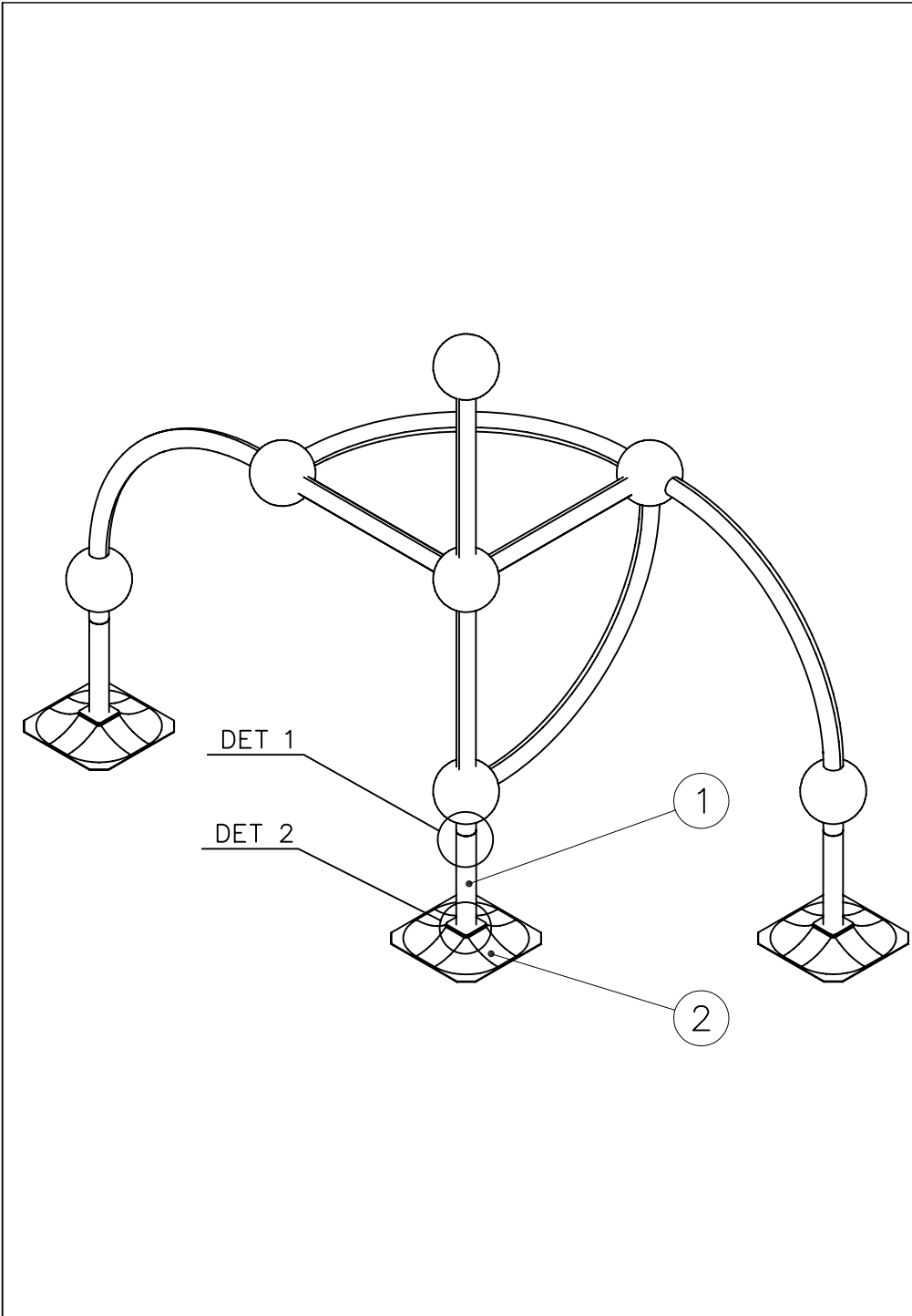

①	701985	PCS	②	702341	PCS
	4			1	
			90x50		
③	702056	PCS	④	902022	PCS
	1			4	
			L 710		
⑤	902134	PCS	⑥	904132	PCS
	8			4	
			L 400		
⑦	904747	PCS			PCS
	28				
60x60x2					
	PCS				PCS
	PCS				PCS
	PCS				PCS
	PCS				PCS

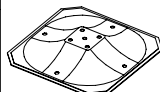

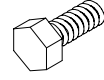
① 902094	PCS	② 909519	PCS
	1		1
Ø60x450		50x380x380	
③ 909637	PCS	④ 909638	PCS
	4		4
M10		Ø20/10,5	
⑤ 909639	PCS		PCS
	4		
M10x25			
	PCS		PCS
	PCS		PCS
	PCS		PCS

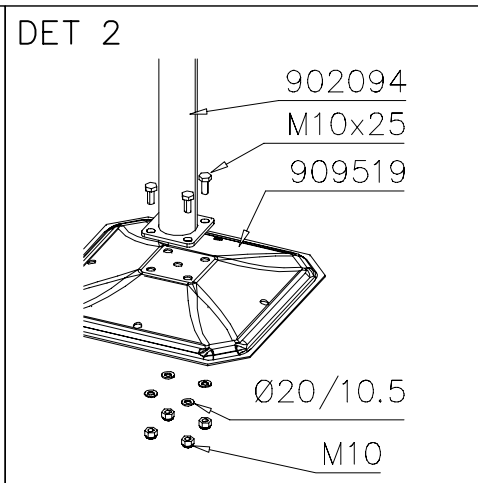
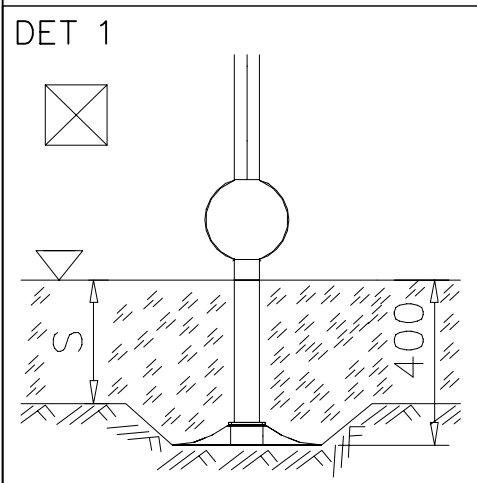











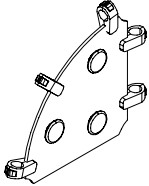
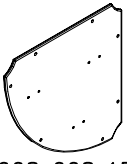
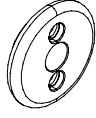
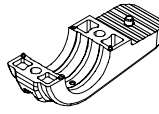

WINAM GROUP

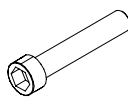
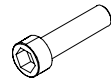
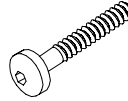
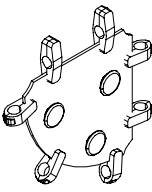
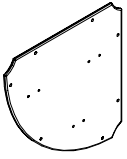
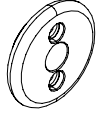
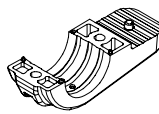
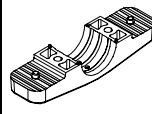
WALL AND FLOOR

CLOXX

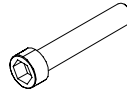
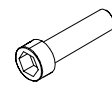
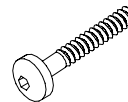
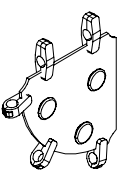
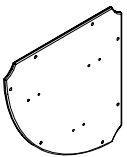
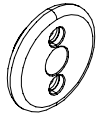
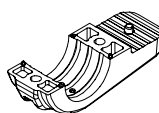
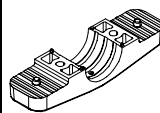
DATE: 3.8.2010

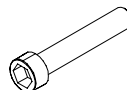
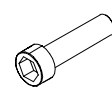
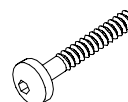

 701967	 668x668x15 701936	PCS 1	 Ø120x30 929322	PCS 3	 150x50x50 902124	PCS 10	 M10 980161	PCS 10	 Ø22 905112	PCS 6	 M8 980150	PCS 6
	 Ø16/8.4x1.6 909256	PCS 6	 M10x55 902232	PCS 5	 M10x30 902233	PCS 5	 M8x45 901899	PCS 6				
		PCS		PCS		PCS		PCS		PCS		PCS
 701987	 668x668x15 701936	PCS 1	 Ø120x30 929322	PCS 3	 150x50x50 902124	PCS 10	 200x50x50 902197	PCS 4	 M10 980161	PCS 14	 Ø22 905112	PCS 6
	 M8 980160	PCS 6	 Ø16/8.4x1.6 909256	PCS 6	 M10x55 902232	PCS 9	 M10x30 902233	PCS 5	 M8x45 901899	PCS 6		
		PCS		PCS		PCS		PCS		PCS		PCS
 702046	 668x668x15 701936	PCS 1	 Ø120x30 929322	PCS 3	 150x50x50 902124	PCS 10	 200x50x50 902197	PCS 4	 M10 980161	PCS 10	 Ø22 905112	PCS 6
	 M8 980150	PCS 6	 Ø16/8.4x1.6 909256	PCS 6	 M10x55 902232	PCS 7	 M10x30 902233	PCS 3	 M8x45 901899	PCS 6		
		PCS		PCS		PCS		PCS		PCS		PCS

WINAM GROUP

WALL AND FLOOR

CLOXX

DATE: 3.8.2010

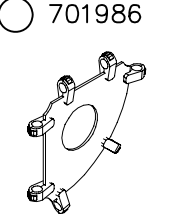
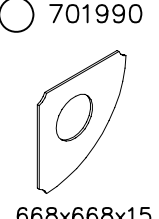
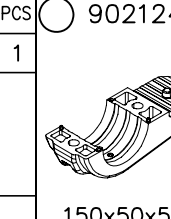
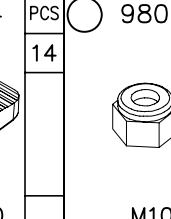
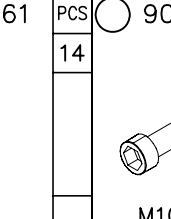
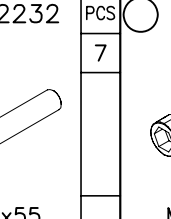
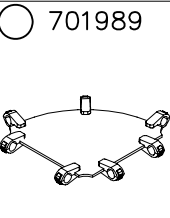
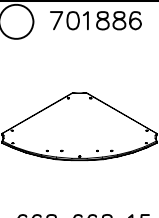
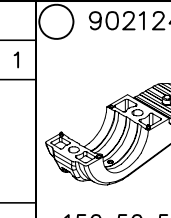
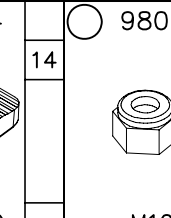
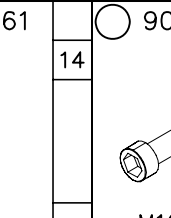
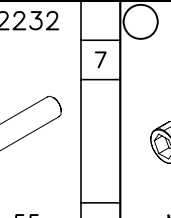
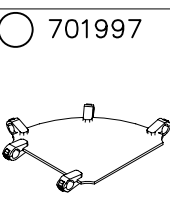
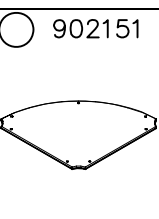
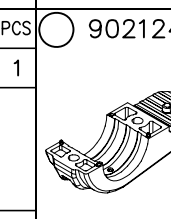
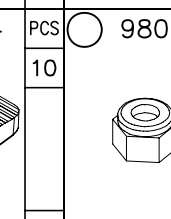
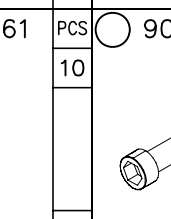
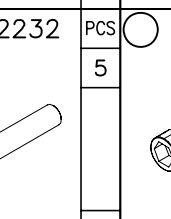
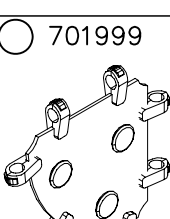
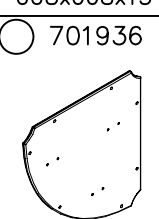
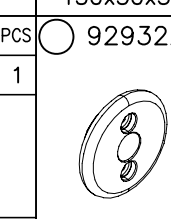
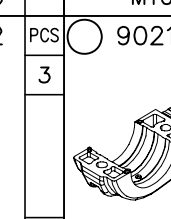
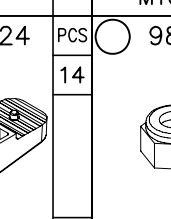
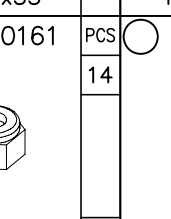
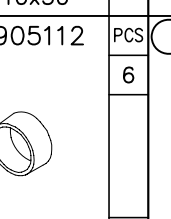
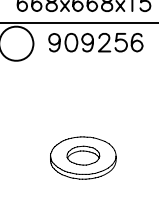
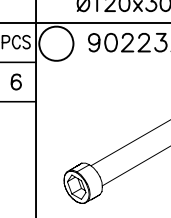
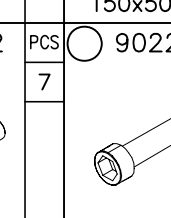
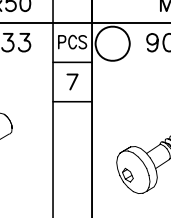
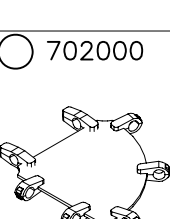
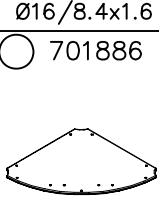
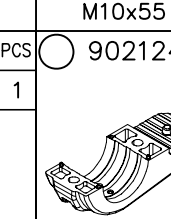
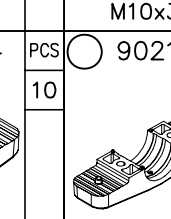
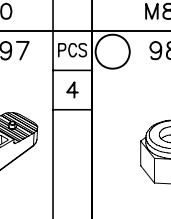
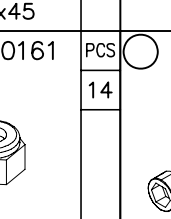
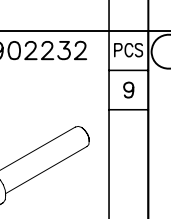
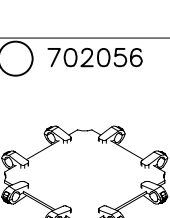
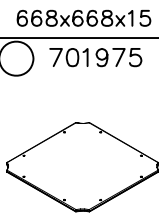
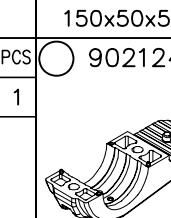
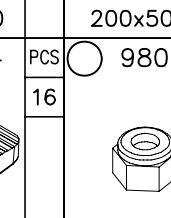
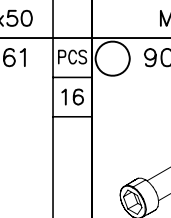
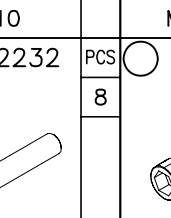
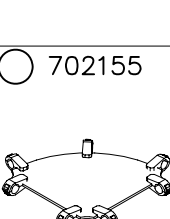
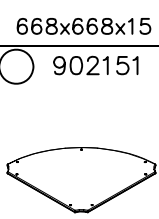
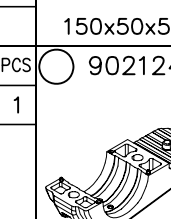
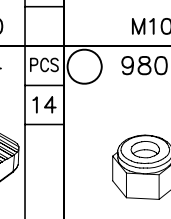
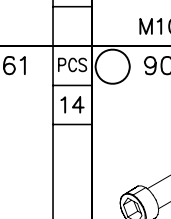
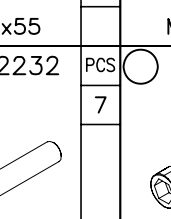

 701986	 701990 668x668x15	PCS 1	 902124 150x50x50	PCS 14	 980161 M10	PCS 14	 902232 M10x55	PCS 7	 902233 M10x30	PCS 7		PCS
 701989	 701886 668x668x15	1	 902124 150x50x50	14	 980161 M10	14	 902232 M10x55	7	 902233 M10x30	7		
 701997	 902151 668x668x15	PCS 1	 902124 150x50x50	PCS 10	 980161 M10	PCS 10	 902232 M10x55	PCS 5	 902233 M10x30	PCS 5		PCS
 701999	 701936 668x668x15	PCS 1	 929322 Ø120x30	PCS 3	 902124 150x50x50	PCS 14	 980161 M10	PCS 14	 905112 Ø22	PCS 6	 980160 M8	PCS 6
	 909256 Ø16/8.4x1.6	PCS 6	 902232 M10x55	PCS 7	 902233 M10x30	PCS 7	 901899 M8x45	PCS 6		PCS		PCS
 702000	 701886 668x668x15	PCS 1	 902124 150x50x50	PCS 10	 902197 200x50x50	PCS 4	 980161 M10	PCS 14	 902232 M10x55	PCS 9	 902233 M10x30	PCS 5
 702056	 701975 668x668x15	PCS 1	 902124 150x50x50	PCS 16	 980161 M10	PCS 16	 902232 M10x55	PCS 8	 902233 M10x30	PCS 8		PCS
 702155	 902151 668x668x15	PCS 1	 902124 150x50x50	PCS 14	 980161 M10	PCS 14	 902232 M10x55	PCS 7	 902233 M10x30	PCS 7		PCS

WINAM GROUP WALL AND FLOOR

CLOXX

DATE: 3.8.2010

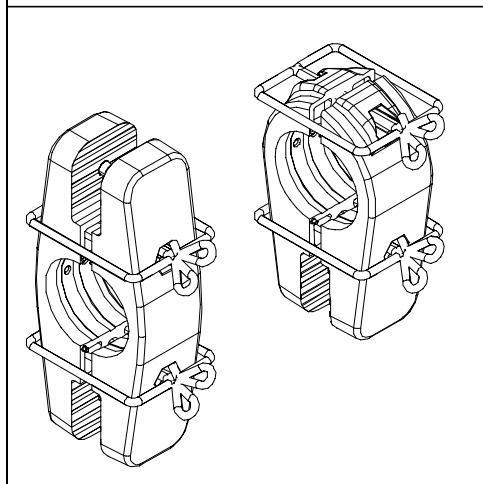
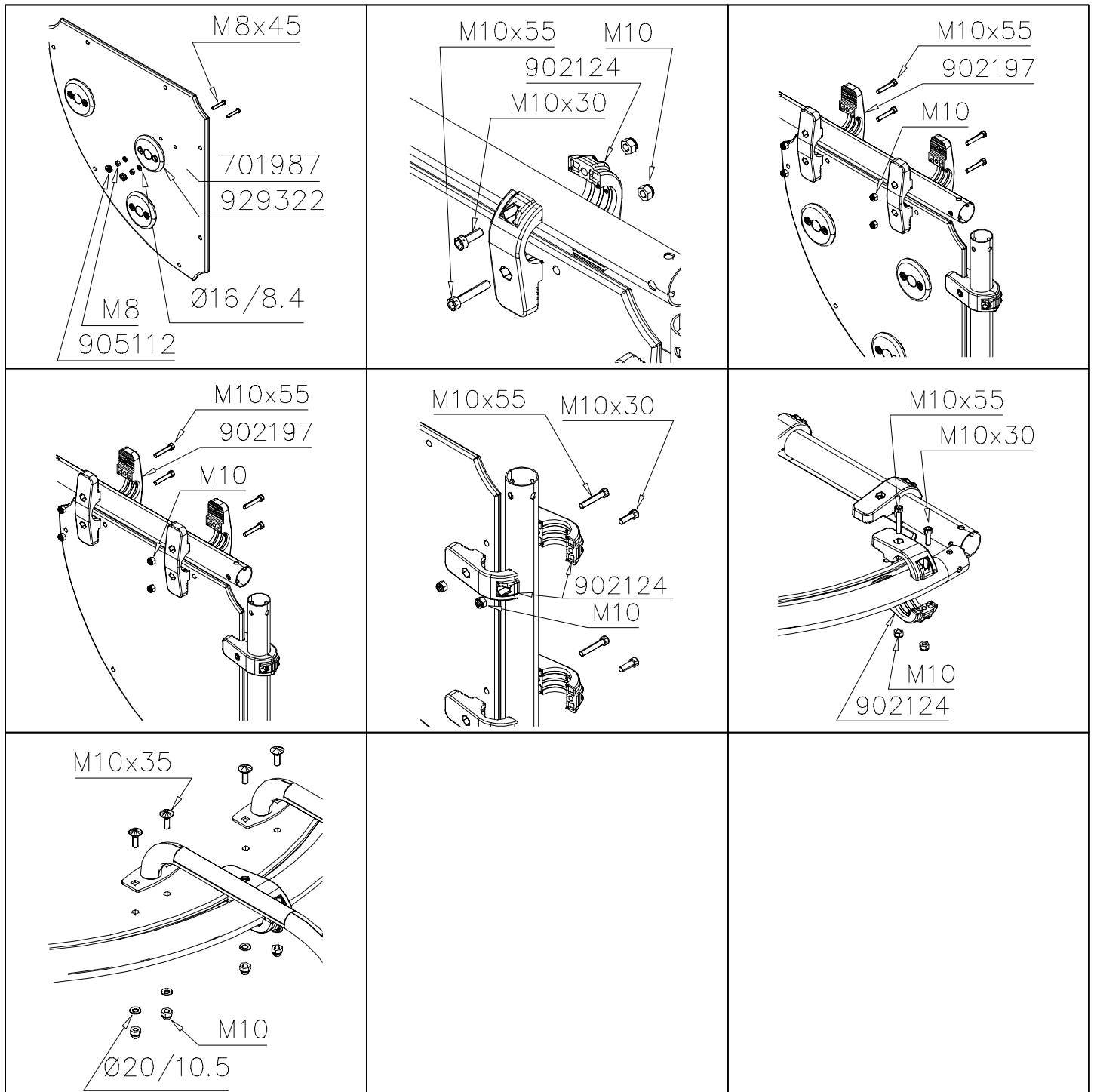

NOTE:
Use a wire marked pairs
of the same junction.

Huom!
Käytä langalla merkittyä
paria samassa liitoksessa.

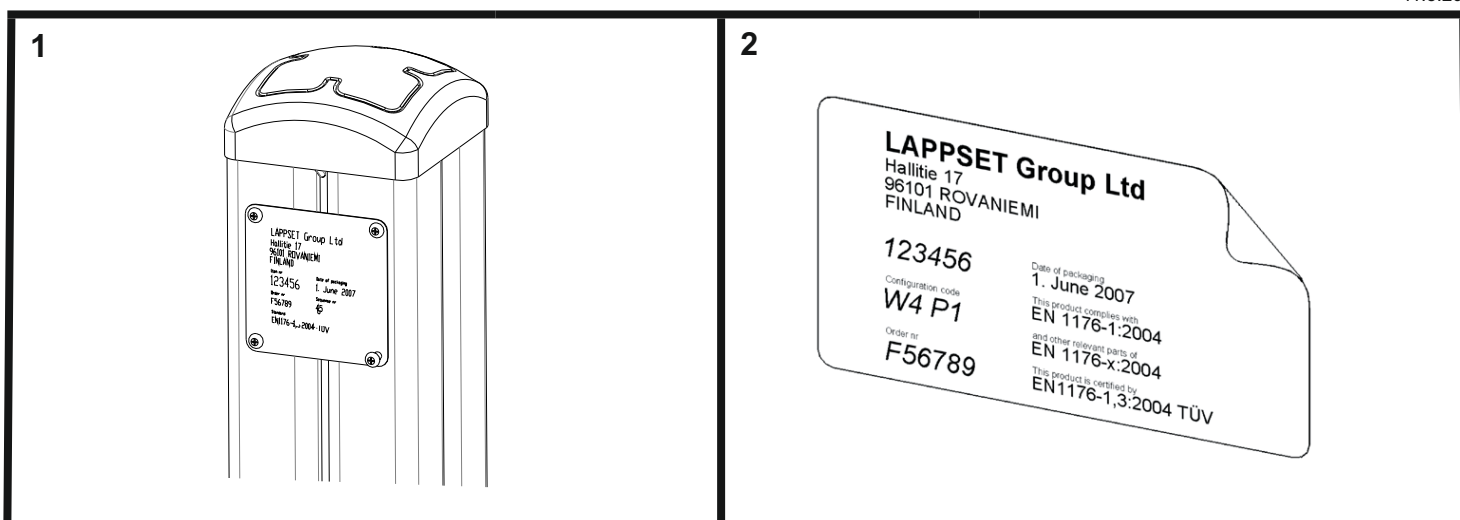

Tuotekyltti tulee tuotteen mukana yhdellä seuraavista tavoista:

1) Metallinen tuotekyltti ja kiinnitysruuvit

- Kiinnitä tuotekyltti ruuveilla tolppaan noin 2 metrin korkeuteen kuvan 2 mukaisesti.

2) Tuotekylttitarra

- Puhdista maalattu metalli- tai vaneripinta pölystä ja kosteudesta. Liimaa tarra kuvan 3 mukaisesti.
- Huom. Älä kiinnitä tarraa karheapintaiseen laminaattiin tai maalattuun puuhun.

Vår produktmärkning levereras på ett av följande sätt:

1) Produktskylt i metall

- Fäst skylten med de medföljande skruvarna

2) Självhäftande produktetikett

- Rengör den pulverlackerad metallytan eller laminerad ytan så att den blir fri från smuts och fukt. Fäst etiketten enligt fig. 3.
- Obs! Fäst ej etiketten på detaljer med skrovlig yta eller på målat trä.

Product label is delivered by one of following ways:

1) Metal product label and screws

- Fasten the label with screws.

2) Label sticker

- Clean the painted metal or plywood surface from dirt and moisture. Fasten the sticker as shown in the figure 3.
- Note. Do not attach the sticker to rough surfaced laminate or painted wood.

La plaque d'informations produit est livrée sous l'une de ces 3 formes :

1) Plaque métallique et vis

- Fixez la plaque à l'aide des vis.

2) Etiquette autocollante

- Avant de coller l'étiquette, nettoyez le composant métallique peint ou la plaque de contreplaqué, de toute saleté. La surface doit être sèche (voir image 3).
- Attention, ne pas coller l'étiquette sur une surface lamellé-collée irrégulière ou sur du bois peint.

Die Auslieferung des Produktaufklebers erfolgt auf eine dieser Arten:

1) Produkt-Schild aus Metall incl. Schrauben



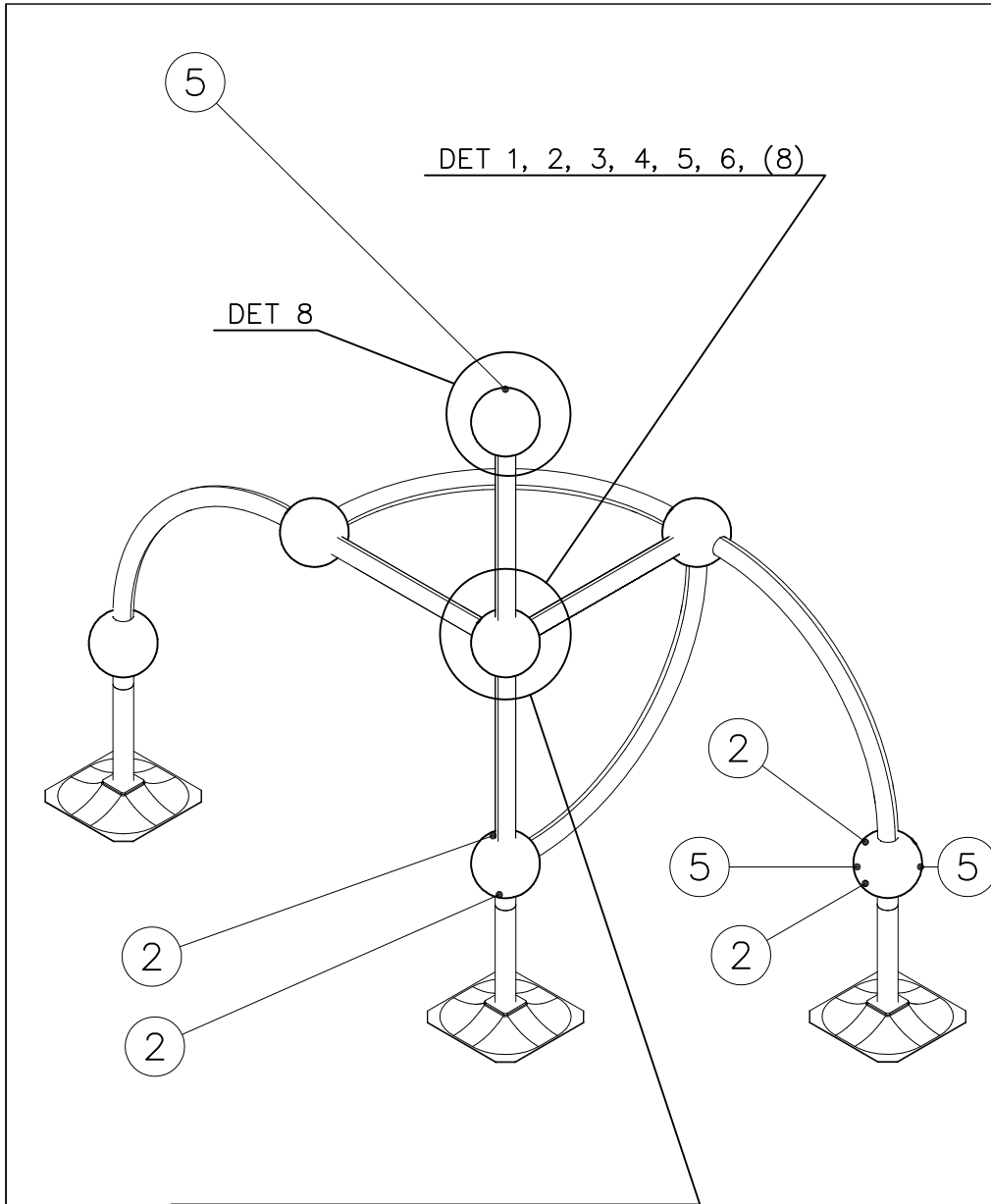

- Die Befestigung des Schildes erfolgt mittels der Schrauben.

2) Aufkleber

- Entfernen Sie zunächst Schmutz und Feuchtigkeit vom lackierten Metall bzw. von der Holzoberfläche und bringen Sie den Aufkleber wie im Bild oben rechts beschrieben auf den gesäuberten Untergrund auf.
- Beachten Sie: Bringen Sie den Aufkleber nicht auf raues laminiertes oder lackiertes Holz an.

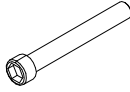

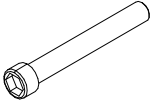
DO NOT TIGHTEN THE JOINTS UNTIL THE STRUCTURE IS COMPLETE.

① 901803	PCS	② 901994	PCS
	2		2
M12x90		Ø190	
③ 902096	PCS	④ 902234	PCS
	4		6
M12x120		M12	
	PCS		PCS
	PCS		PCS
	PCS		PCS
	PCS		PCS
	PCS		PCS

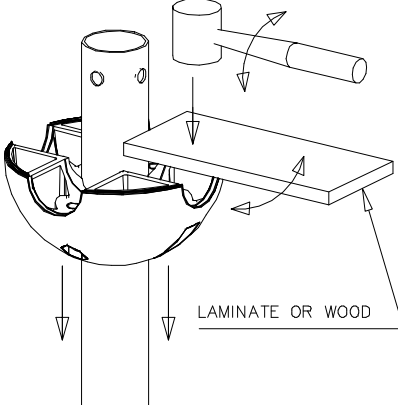
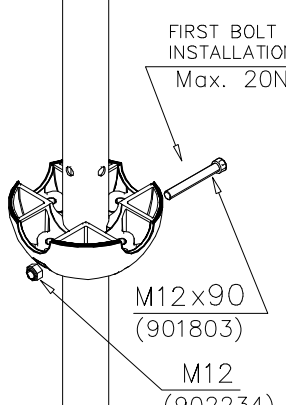
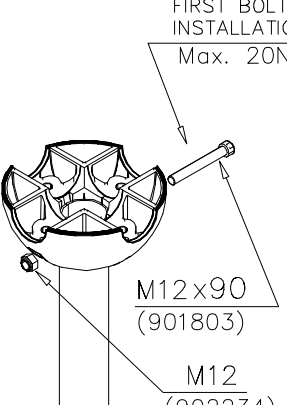
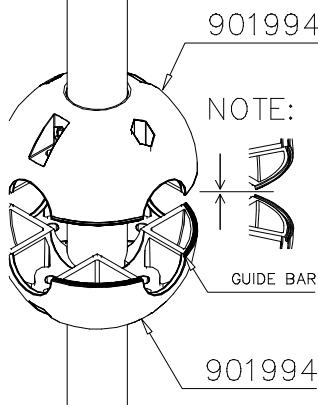
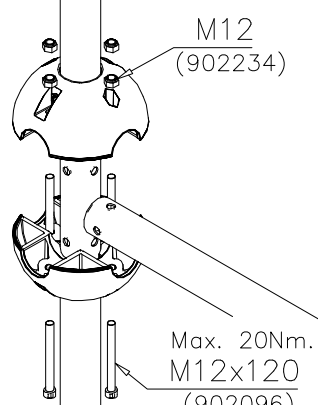
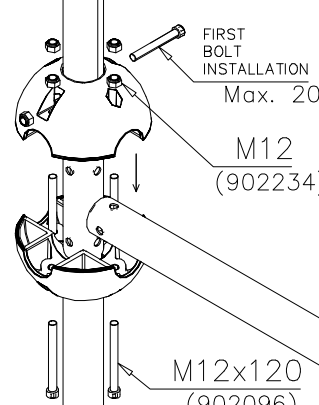
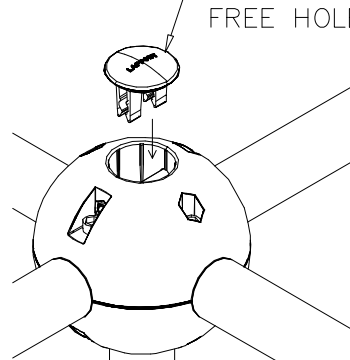
<p>DET 1</p> 	<p>DET 2</p> 	<p>DET 3</p> 
<p>DET 4</p> 	<p>DET 5</p> 	<p>DET 6</p> 
<p>REMEMBER FINAL TIGHTENING</p>	<p>DET 7</p> 	<p>DET 8</p> 