

— EN Impact Area 6.6 m²
 - - - Falling Space 6.6 m²
 Max Falling Height 600 mm

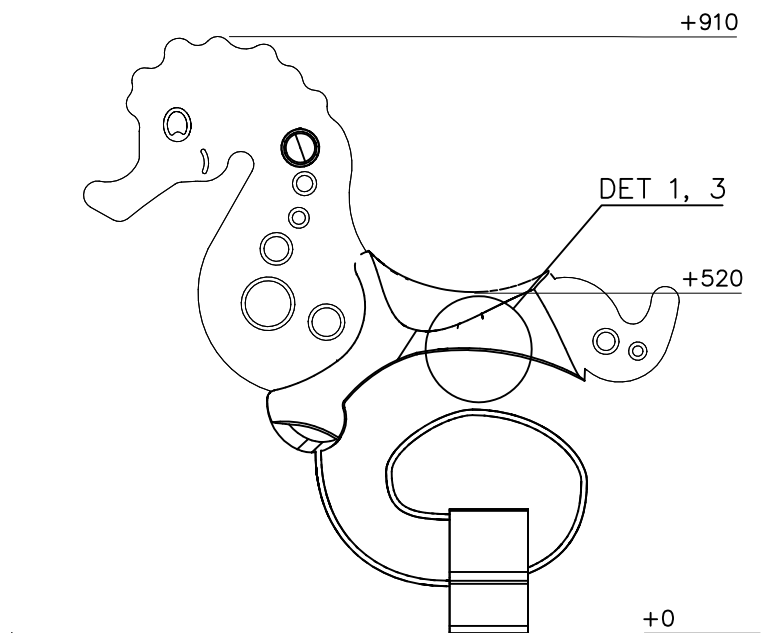

DATE: 15.4.2021

DET 1

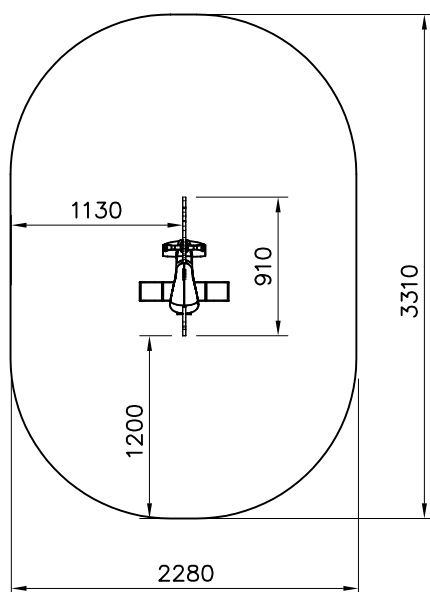
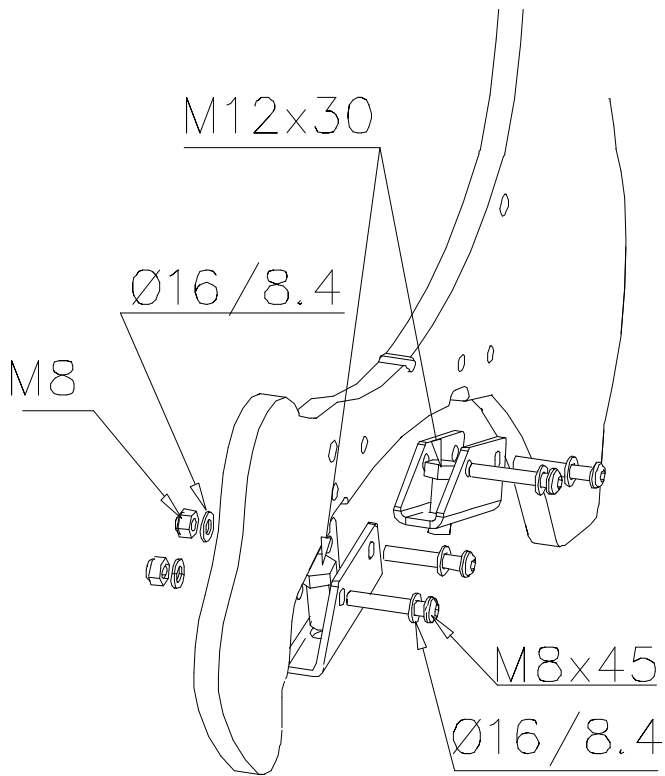

DET 2

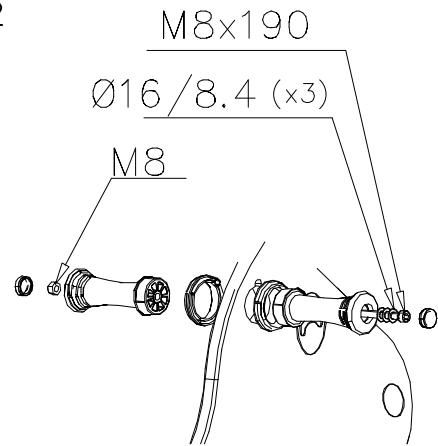

DET 3

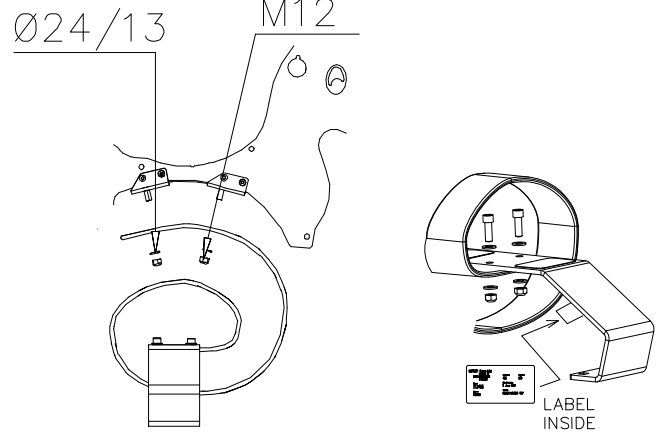



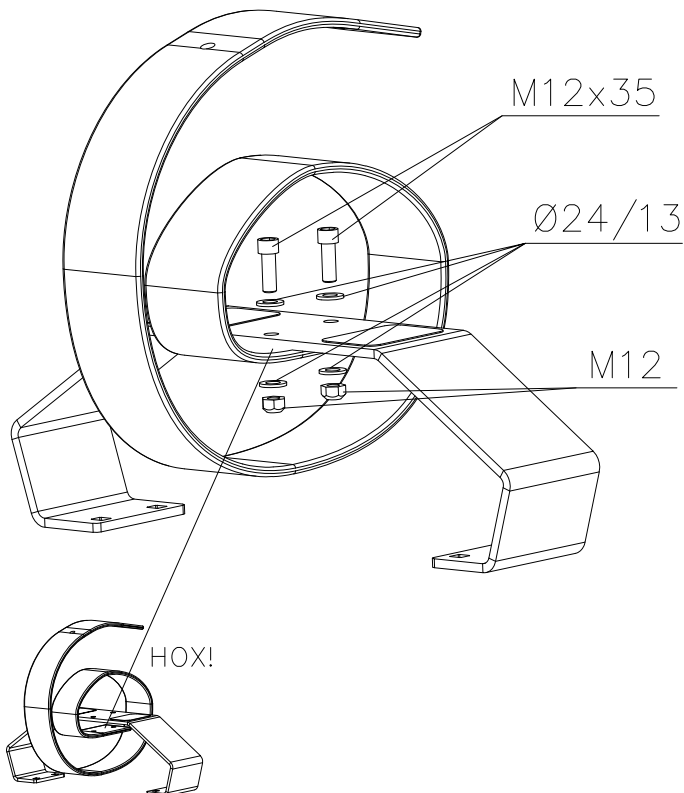



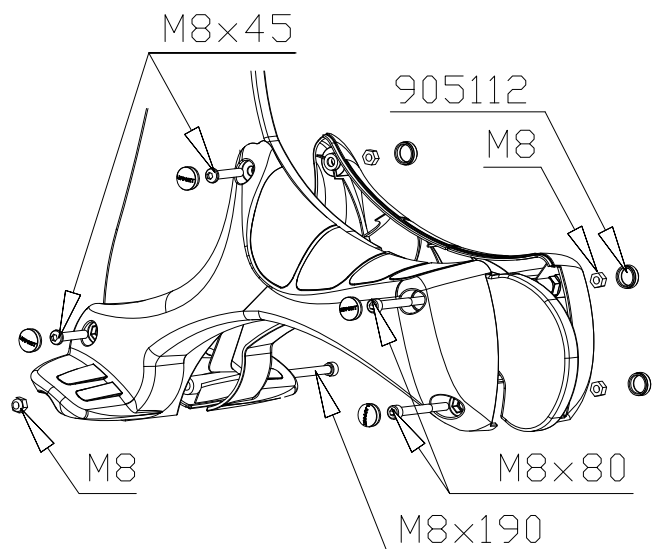

DET 4

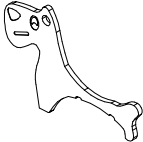

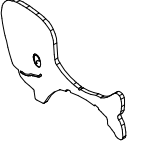
DET 5

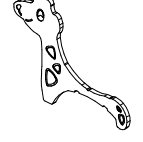
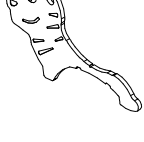

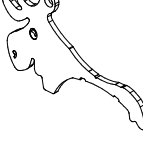
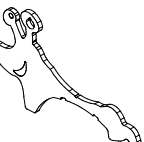
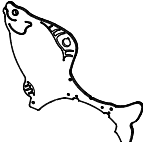

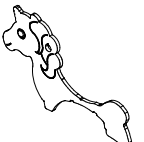





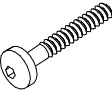
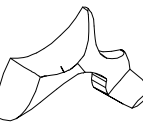
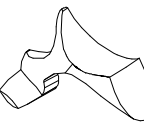

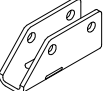

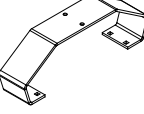

DATE: 15.4.2021

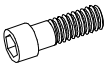
① 701988 (010501)	PCS 1	① 701960 (010502)	PCS 1	① 701991 (010503)	PCS 1	① 702025 (010504)	PCS 1	① 702023 (010505)	PCS 1	① 702024 (010506)	PCS 1
											
① 702028 (010507)	PCS 1	① 702027 (010508)	PCS 1	① 704435 (010509)	PCS 1	① 704436 (010510)	PCS 1	① 704437 (010511)	PCS 1	① 706329 (010512)	PCS 1
											
① 706331 (010513)	PCS 1	① 707751 (010514)	PCS 1	① 707571 (010516)	PCS 1	① 710192 (Q41143)	PCS 1				
											

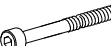
707014



② 901899	PCS 6	③ 902095	PCS 1	④ 902133	PCS 1	⑤ 902211	PCS 2	⑥ 902303	PCS 2	⑦ 903149	PCS 2
											
M8x45		RIGHT		LEFT						M12x30	
⑧ 905023	PCS 2	⑨ 905032	PCS 1	⑩ 905106	PCS 1	⑪ 905112	PCS 10	⑫ 906511	PCS 4	⑬ 909146	PCS 2
											
		8,5x90		590x190x120		Ø22		M12		M12x35	
⑭ 909195	PCS 2	⑮ 909340	PCS 2	⑯ 980150	PCS 10	⑰ 980151	PCS 11	⑱ 980154	PCS 6		
											
M8x190		M8x80		M8		Ø16/8.4		Ø24/13			

⑲ 702286	PCS 1	
		
90x50		

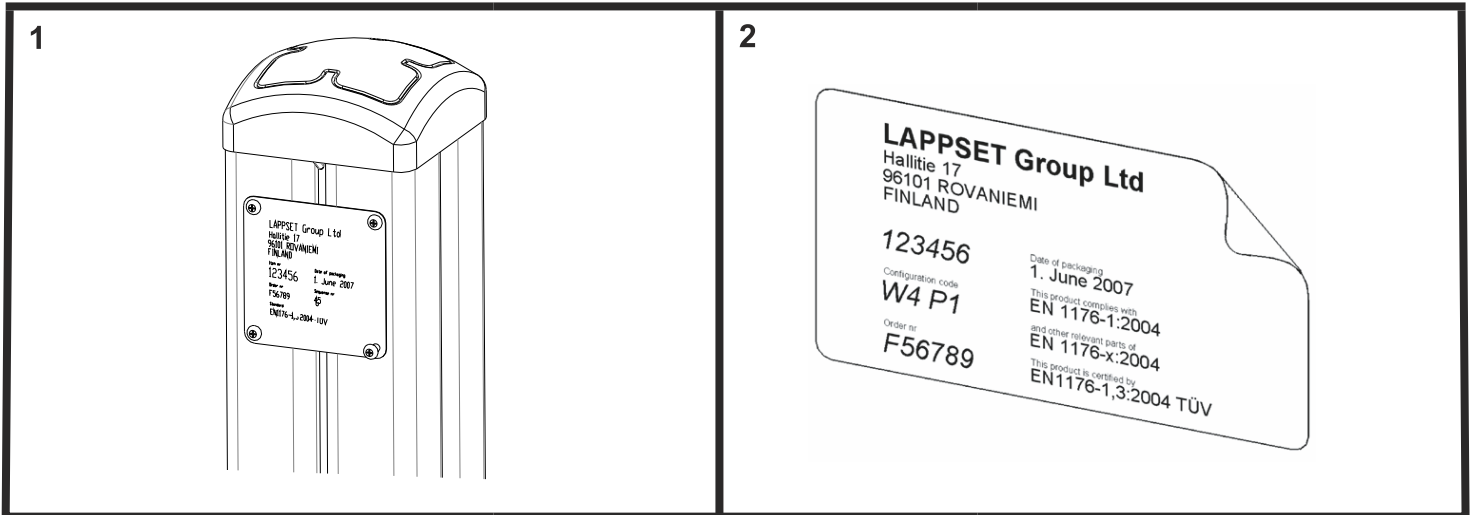

Tuotekyltti tulee tuotteen mukana yhdellä seuraavista tavoista:

1) Metallinen tuotekyltti ja kiinnitysruuvit

- Kiinnitä tuotekyltti ruuveilla tolppaan noin 2 metrin korkeuteen kuvan 1 mukaisesti.

2) Tuotekylttitarra

- Puhdista maalattu metalli- tai vaneripinta pölystä ja kosteudesta. Liimaa tarra kuvan 2 mukaisesti.
- Huom. Älä kiinnitä tarraa karheapintaiseen laminaattiin tai maalattuun puuhun.

Vår produktmärkning levereras på ett av följande sätt:

1) Produktskylt i metall

- Fäst skylten med de medföljande skruvarna

2) Självhäftande produktetikett

- Rengör den pulverlackerade metallytan eller laminatyten så att den blir fri från smuts och fukt. Fäst etiketten enligt fig. 2.
- Obs! Fäst ej etiketten på detaljer med skrovlig yta eller på målat trä.

Product label is delivered by one of following ways:

1) Metal product label and screws

- Fasten the label with screws.

2) Label sticker

- Clean the painted metal or plywood surface from dirt and moisture. Fasten the sticker as shown in the figure 2.
- Note. Do not attach the sticker to rough surfaced laminate or painted wood.

La plaque d'informations produit est livrée sous l'une de ces 3 formes :

1) Plaque métallique et vis

- Fixez la plaque à l'aide des vis.

2) Etiquette autocollante

- Avant de coller l'étiquette, nettoyez le composant métallique peint ou la plaque de contreplaqué, de toute saleté. La surface doit être sèche (voir image 2).
- Attention, ne pas coller l'étiquette sur une surface lamellé-collée irrégulière ou sur du bois peint.

Die Auslieferung des Produktaufklebers erfolgt auf eine dieser Arten:

1) Produkt-Schild aus Metall incl. Schrauben

- Die Befestigung des Schildes erfolgt mittels der Schrauben.

2) Aufkleber

- Entfernen Sie zunächst Schmutz und Feuchtigkeit vom lackierten Metall bzw. von der Holzoberfläche und bringen Sie den Aufkleber wie im Bild oben rechts beschrieben auf den gesäuberten Untergrund auf.
- Beachten Sie: Bringen Sie den Aufkleber nicht auf raues laminiertes oder lackiertes Holz an.