

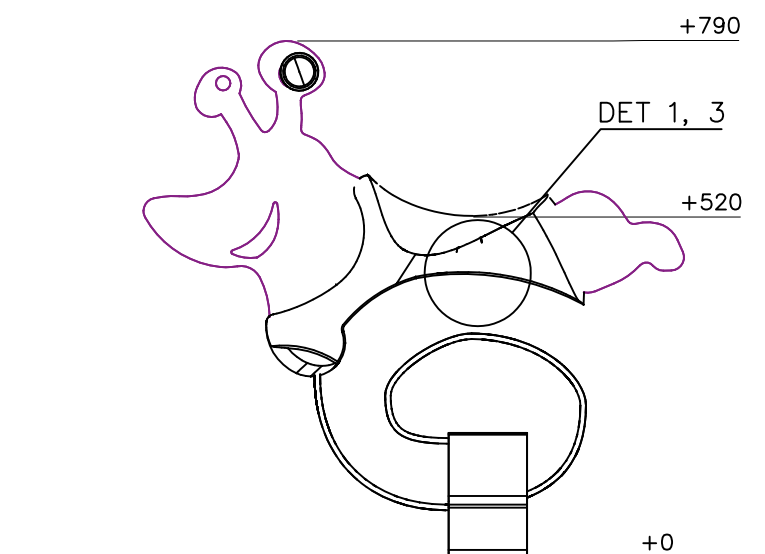

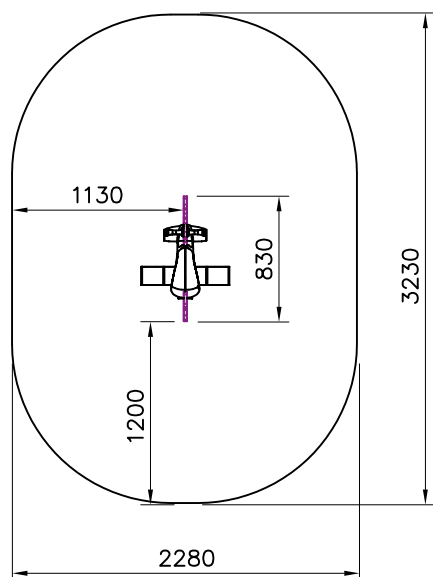

—— EN Impact Area 6.5 m2  
 - - - - Falling Space 6.5 m2  
 Max Falling Height 600 mm

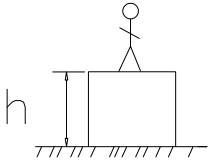

												
<p><b><math>h &lt; 600</math></b></p> <p>Without movement and therefore without Impact Area</p>	<p>Totally hard surfaces.</p> <p>Note. Lappset does <u>not</u> recommend totally hard surfaces at all.</p>	<p>E.g. concrete or asphalt</p> 										
<p><b><math>h &lt; 600</math></b></p> <p>With movement e.g. rocking</p>	<p>Materials with very limited impact attenuating properties.</p>	<p>E.g. wood</p> 										
<p><b><math>h &lt; 1000</math></b></p>	<p>Materials with significant impact attenuating properties.</p>	<p>fine gravel 0–8 mm</p>  <p>grass</p>  <p>unsorted sand</p> 										
<p><b><math>h &lt; 3000</math></b></p>	<p>Loose fill material</p> <p>E.g. sand/gravel 0,25...8 mm D60/D10&lt;3,0 Woodchips 5...30 mm bark 20...80 mm</p>	 <table data-bbox="1024 1691 1324 1780"> <tr> <td><math>\underline{S}</math></td> <td><math>\underline{h}</math></td> </tr> <tr> <td>30 cm</td> <td>&lt; 2,0 m</td> </tr> <tr> <td>40 cm</td> <td>&lt; 3,0 m</td> </tr> </table>	$\underline{S}$	$\underline{h}$	30 cm	< 2,0 m	40 cm	< 3,0 m				
$\underline{S}$	$\underline{h}$											
30 cm	< 2,0 m											
40 cm	< 3,0 m											
	<p>Syntethic granulates</p> <table data-bbox="406 1892 750 2060"> <tr> <td><math>\underline{S}</math></td> <td><math>\underline{h}</math></td> </tr> <tr> <td>40 mm</td> <td>~&gt; 1,2...1,3 m</td> </tr> <tr> <td>50 mm</td> <td>~&gt; 1,5...1,7 m</td> </tr> <tr> <td>60 mm</td> <td>~&gt; 1,8...2,0 m</td> </tr> <tr> <td>70 mm</td> <td>~&gt; 2,1...2,5 m</td> </tr> </table> <p>Note. For accurate values, see manufacturer's instructions.</p>	$\underline{S}$	$\underline{h}$	40 mm	~> 1,2...1,3 m	50 mm	~> 1,5...1,7 m	60 mm	~> 1,8...2,0 m	70 mm	~> 2,1...2,5 m	
$\underline{S}$	$\underline{h}$											
40 mm	~> 1,2...1,3 m											
50 mm	~> 1,5...1,7 m											
60 mm	~> 1,8...2,0 m											
70 mm	~> 2,1...2,5 m											

REMOVE SAFETY SURFACE/SAND/GRAVEL  
TO CHECK FOUNDATION

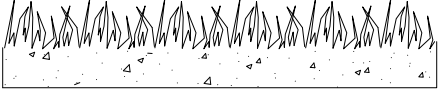
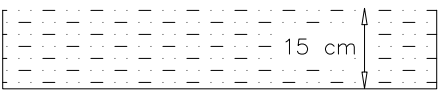
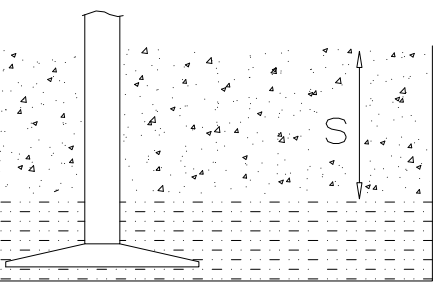
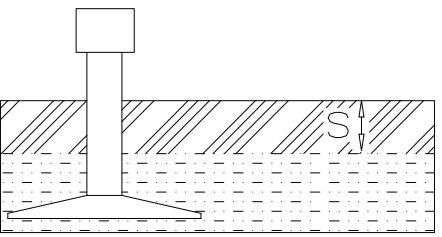
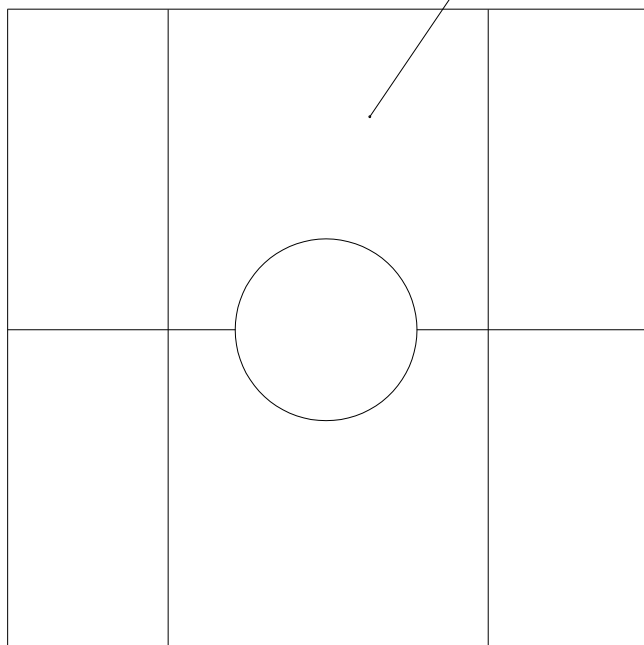

REMOVE SAFETY SURFACE/SAND/GRAVEL  
TO CHECK FOUNDATION

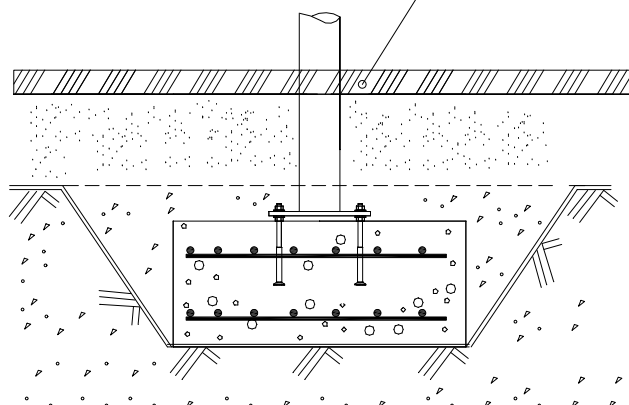

DET 1

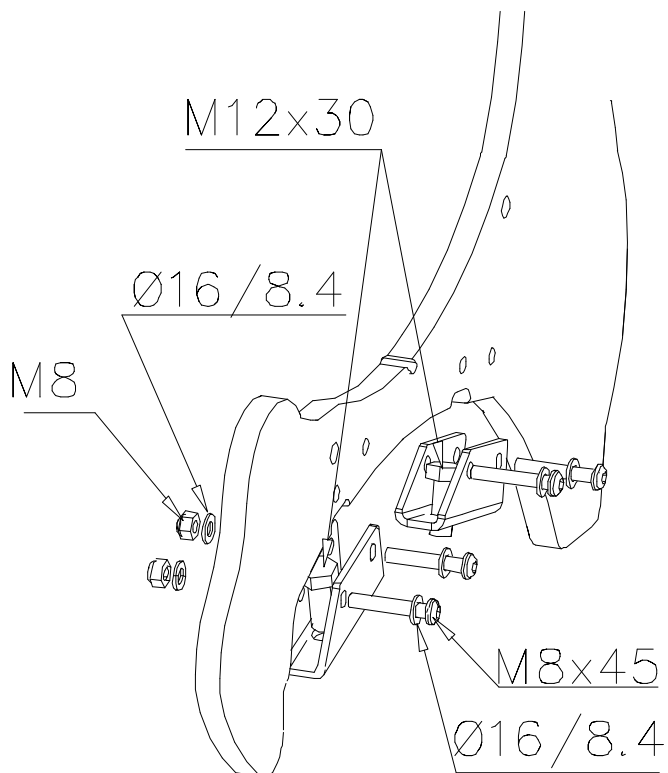

DET 2

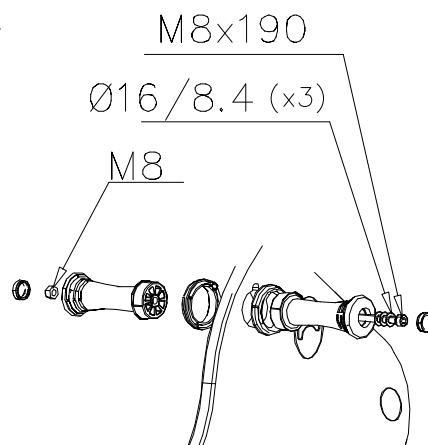

DET 3

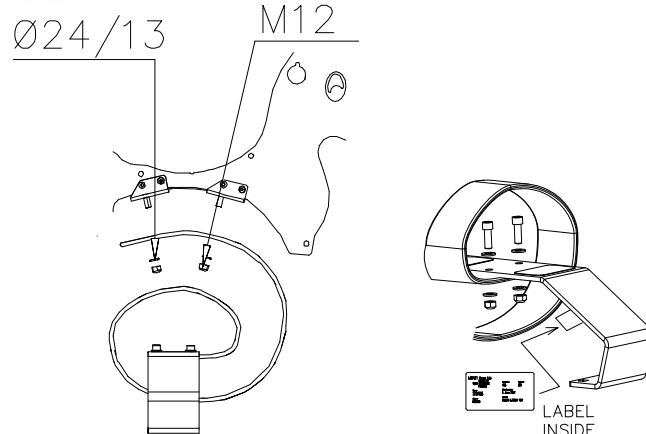



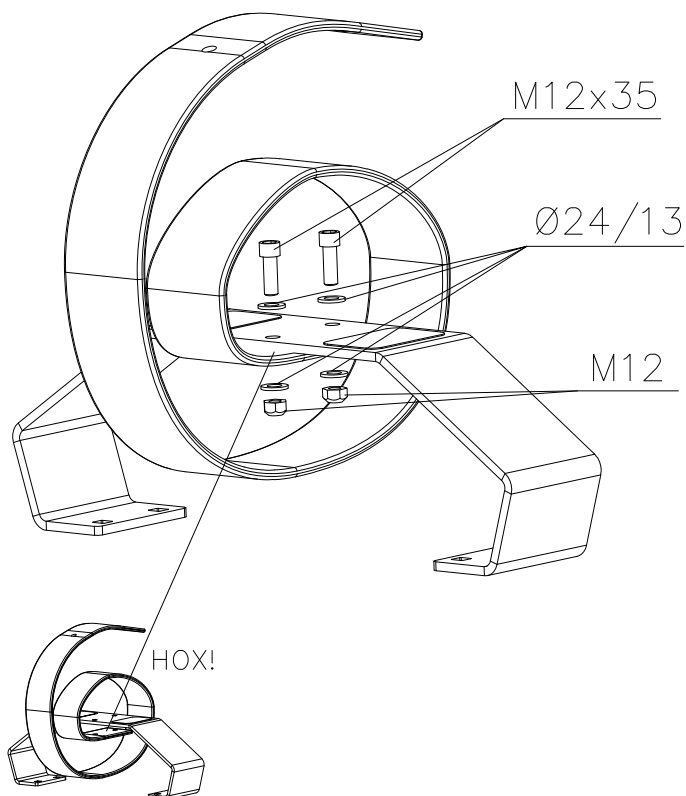



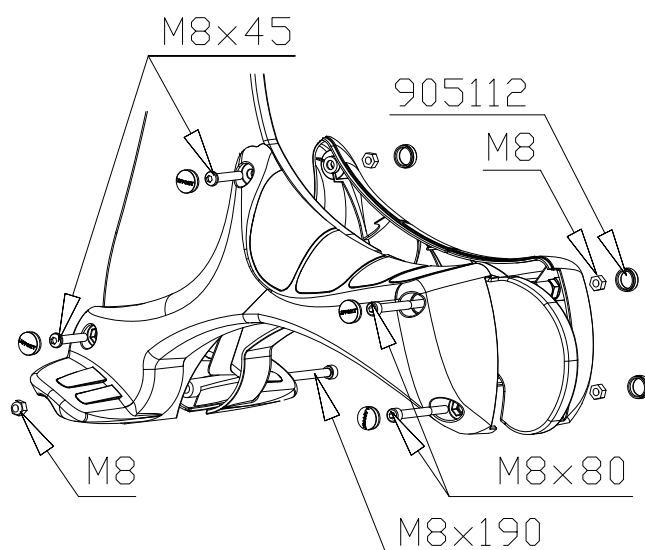





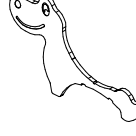

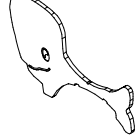
DET 4

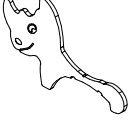
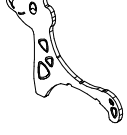

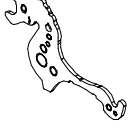
DET 5

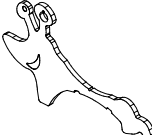

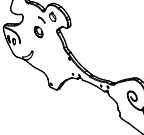







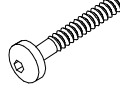

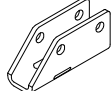
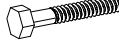
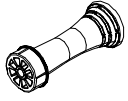
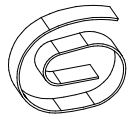
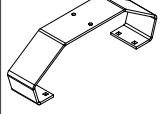

DATE: 15.4.2021

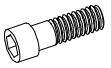
① 701988 (010501)	PCS 1	① 701960 (010502)	PCS 1	① 701991 (010503)	PCS 1	① 702025 (010504)	PCS 1	① 702023 (010505)	PCS 1	① 702024 (010506)	PCS 1
											
① 702028 (010507)	PCS 1	① 702027 (010508)	PCS 1	① 704435 (010509)	PCS 1	① 704436 (010510)	PCS 1	① 704437 (010511)	PCS 1	① 706329 (010512)	PCS 1
											
① 706331 (010513)	PCS 1	① 707751 (010514)	PCS 1	① 707571 (010516)	PCS 1	① 710192 (Q41143)	PCS 1				
											

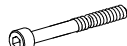
707014



② 901899	PCS 6	③ 902095	PCS 1	④ 902133	PCS 1	⑤ 902211	PCS 2	⑥ 902303	PCS 2	⑦ 903149	PCS 2
											
M8x45		RIGHT		LEFT						M12x30	
⑧ 905023	PCS 2	⑨ 905032	PCS 1	⑩ 905106	PCS 1	⑪ 905112	PCS 10	⑫ 906511	PCS 4	⑬ 909146	PCS 2
											
		8,5x90		590x190x120		Ø22		M12		M12x35	
⑭ 909195	PCS 2	⑮ 909340	PCS 2	⑯ 980150	PCS 10	⑰ 980151	PCS 11	⑱ 980154	PCS 6		
											
M8x190		M8x80		M8		Ø16/8.4		Ø24/13			

⑲ 702286	PCS 1	
		
90x50		

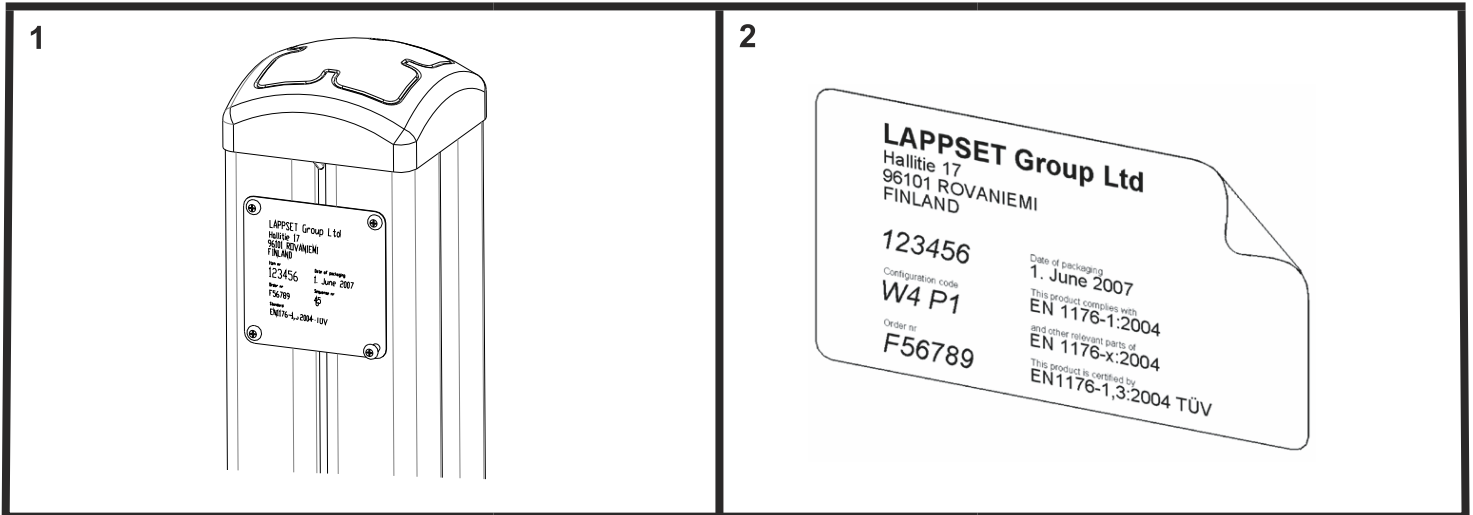

**Tuotekyltti tulee tuotteen mukana yhdellä seuraavista tavoista:**

**1) Metallinen tuotekyltti ja kiinnitysruuvit**

- Kiinnitä tuotekyltti ruuveilla tolppaan noin 2 metrin korkeuteen kuvan 1 mukaisesti.

**2) Tuotekylttitarra**

- Puhdista maalattu metalli- tai vaneripinta pölystä ja kosteudesta. Liimaa tarra kuvan 2 mukaisesti.
- Huom. Älä kiinnitä tarraa karheapintaiseen laminaattiin tai maalattuun puuhun.

**Vår produktmärkning levereras på ett av följande sätt:**

**1) Produktskylt i metall**

- Fäst skylten med de medföljande skruvarna

**2) Självhäftande produktetikett**

- Rengör den pulverlackerade metallytan eller laminatyten så att den blir fri från smuts och fukt. Fäst etiketten enligt fig. 2.
- Obs! Fäst ej etiketten på detaljer med skrovlig yta eller på målat trä.

**Product label is delivered by one of following ways:**

**1) Metal product label and screws**

- Fasten the label with screws.

**2) Label sticker**

- Clean the painted metal or plywood surface from dirt and moisture. Fasten the sticker as shown in the figure 2.
- Note. Do not attach the sticker to rough surfaced laminate or painted wood.

**La plaque d'informations produit est livrée sous l'une de ces 3 formes :**

**1) Plaque métallique et vis**

- Fixez la plaque à l'aide des vis.

**2) Etiquette autocollante**

- Avant de coller l'étiquette, nettoyez le composant métallique peint ou la plaque de contreplaqué, de toute saleté. La surface doit être sèche (voir image 2).
- Attention, ne pas coller l'étiquette sur une surface lamellé-collée irrégulière ou sur du bois peint.

**Die Auslieferung des Produktaufklebers erfolgt auf eine dieser Arten:**

**1) Produkt-Schild aus Metall incl. Schrauben**

- Die Befestigung des Schildes erfolgt mittels der Schrauben.

**2) Aufkleber**

- Entfernen Sie zunächst Schmutz und Feuchtigkeit vom lackierten Metall bzw. von der Holzoberfläche und bringen Sie den Aufkleber wie im Bild oben rechts beschrieben auf den gesäuberten Untergrund auf.
- Beachten Sie: Bringen Sie den Aufkleber nicht auf raues laminiertes oder lackiertes Holz an.