

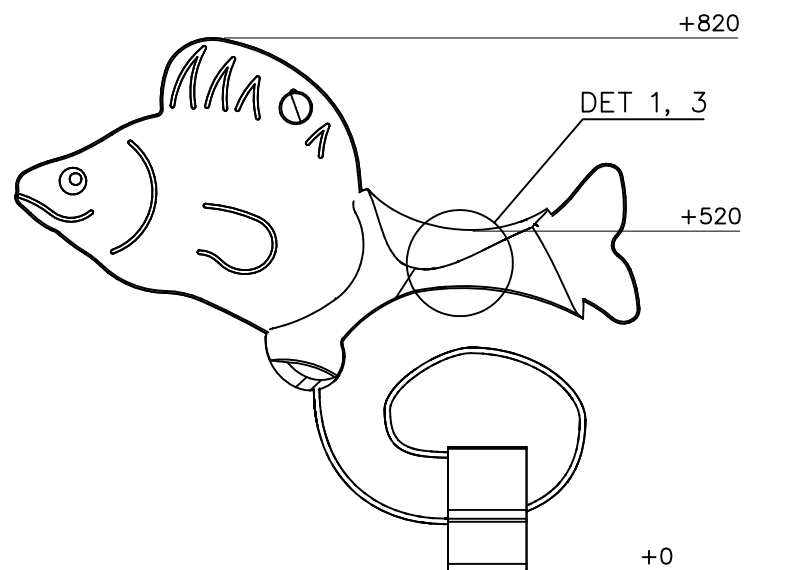

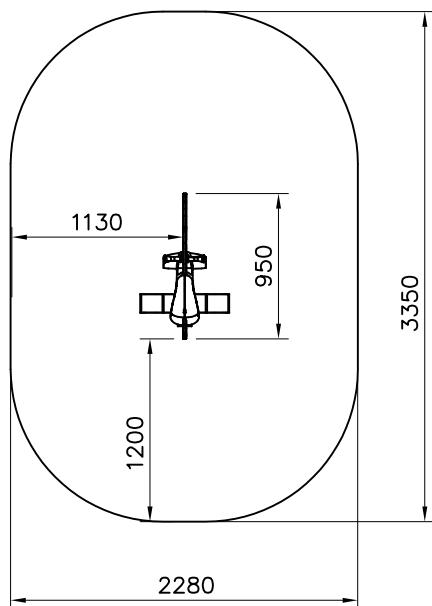

—— EN Impact Area 6.8 m²
 - - - - Falling Space 6.8 m²
 Max Falling Height 600 mm

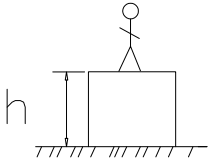

												
<p>$h < 600$</p> <p>Without movement and therefore without Impact Area</p>	<p>Totally hard surfaces.</p> <p>Note. Lappset does <u>not recommend</u> totally hard surfaces at all.</p>	<p>E.g. concrete or asphalt</p> 										
<p>$h < 600$</p> <p>With movement e.g. rocking</p>	<p>Materials with very limited impact attenuating properties.</p>	<p>E.g. wood</p> 										
<p>$h < 1000$</p>	<p>Materials with significant impact attenuating properties.</p>	<p>fine gravel 0–8 mm</p>  <p>grass</p>  <p>unsorted sand</p> 										
<p>$h < 3000$</p>	<p>Loose fill material</p> <p>E.g. sand/gravel 0,25...8 mm D60/D10<3,0 Woodchips 5...30 mm bark 20...80 mm</p>	 <table data-bbox="1024 1691 1332 1780"> <tr> <td>\underline{S}</td> <td>\underline{h}</td> </tr> <tr> <td>30 cm</td> <td>< 2,0 m</td> </tr> <tr> <td>40 cm</td> <td>< 3,0 m</td> </tr> </table>	\underline{S}	\underline{h}	30 cm	< 2,0 m	40 cm	< 3,0 m				
\underline{S}	\underline{h}											
30 cm	< 2,0 m											
40 cm	< 3,0 m											
	<p>Syntethic granulates</p> <table data-bbox="406 1892 758 2060"> <tr> <td>\underline{S}</td> <td>\underline{h}</td> </tr> <tr> <td>40 mm</td> <td>~> 1,2...1,3 m</td> </tr> <tr> <td>50 mm</td> <td>~> 1,5...1,7 m</td> </tr> <tr> <td>60 mm</td> <td>~> 1,8...2,0 m</td> </tr> <tr> <td>70 mm</td> <td>~> 2,1...2,5 m</td> </tr> </table> <p>Note. For accurate values, see manufacturer's instructions.</p>	\underline{S}	\underline{h}	40 mm	~> 1,2...1,3 m	50 mm	~> 1,5...1,7 m	60 mm	~> 1,8...2,0 m	70 mm	~> 2,1...2,5 m	
\underline{S}	\underline{h}											
40 mm	~> 1,2...1,3 m											
50 mm	~> 1,5...1,7 m											
60 mm	~> 1,8...2,0 m											
70 mm	~> 2,1...2,5 m											

REMOVE SAFETY SURFACE/SAND/GRAVEL
TO CHECK FOUNDATION

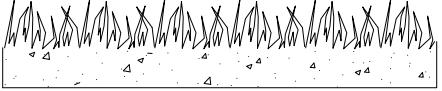
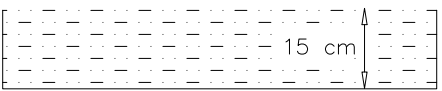
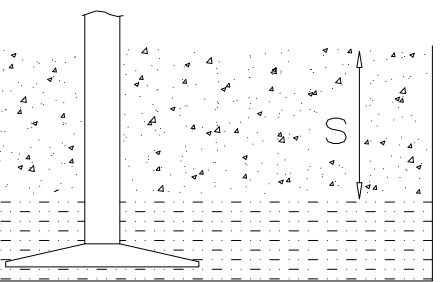
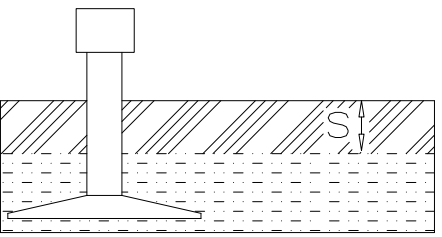
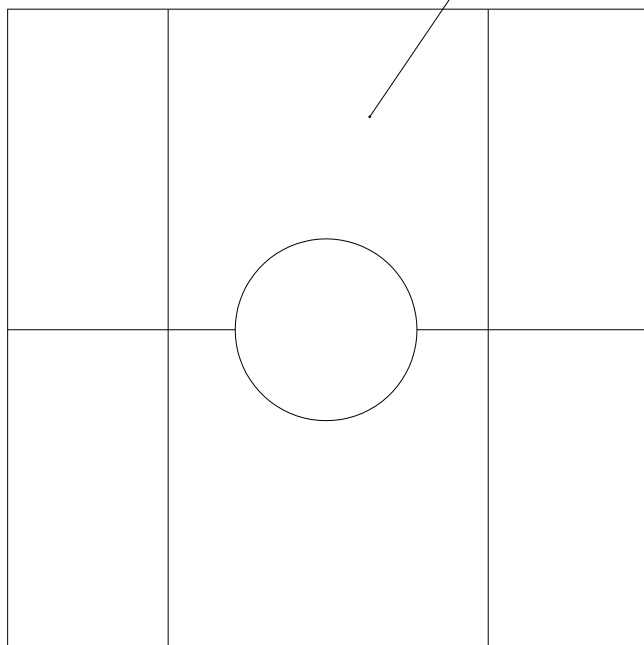

REMOVE SAFETY SURFACE/SAND/GRAVEL
TO CHECK FOUNDATION

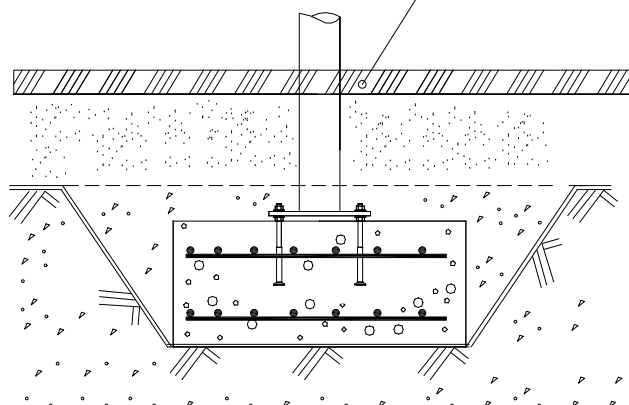



Tuotekyltti tulee tuotteen mukana yhdellä seuraavista tavoista:

1) Metallinen tuotekyltti ja kiinnitysruuvit

- Kiinnitä tuotekyltti ruuveilla tolppaan noin 2 metrin korkeuteen kuvan 1 mukaisesti.

2) Tuotekyltitarra

- Puhdista maalattu metalli- tai vaneripinta pölystä ja kosteudesta. Liimaa tarra kuvan 2 mukaisesti.
- Huom. Älä kiinnitä tarraa karheapintaiseen laminaattiin tai maalattuun puuhun.

Vår produktmärkning levereras på ett av följande sätt:

1) Produktskylt i metall

- Fäst skylten med de medföljande skruvarna

2) Självhäftande produktetikett

- Rengör den pulverlackerade metallytan eller laminatyten så att den blir fri från smuts och fukt. Fäst etiketten enligt fig. 2.
- Obs! Fäst ej etiketten på detaljer med skrovlig yta eller på målat trä.

Product label is delivered by one of following ways:

1) Metal product label and screws

- Fasten the label with screws.

2) Label sticker

- Clean the painted metal or plywood surface from dirt and moisture. Fasten the sticker as shown in the figure 2.
- Note. Do not attach the sticker to rough surfaced laminate or painted wood.

La plaque d'informations produit est livrée sous l'une de ces 3 formes :

1) Plaque métallique et vis

- Fixez la plaque à l'aide des vis.

2) Etiquette autocollante

- Avant de coller l'étiquette, nettoyez le composant métallique peint ou la plaque de contreplaqué, de toute saleté. La surface doit être sèche (voir image 2).
- Attention, ne pas coller l'étiquette sur une surface lamellé-collée irrégulière ou sur du bois peint.

Die Auslieferung des Produktaufklebers erfolgt auf eine dieser Arten:

1) Produkt-Schild aus Metall incl. Schrauben

- Die Befestigung des Schildes erfolgt mittels der Schrauben.

2) Aufkleber

- Entfernen Sie zunächst Schmutz und Feuchtigkeit vom lackierten Metall bzw. von der Holzoberfläche und bringen Sie den Aufkleber wie im Bild oben rechts beschrieben auf den gesäuberten Untergrund auf.
- Beachten Sie: Bringen Sie den Aufkleber nicht auf raues laminiertes oder lackiertes Holz an.

DET 1

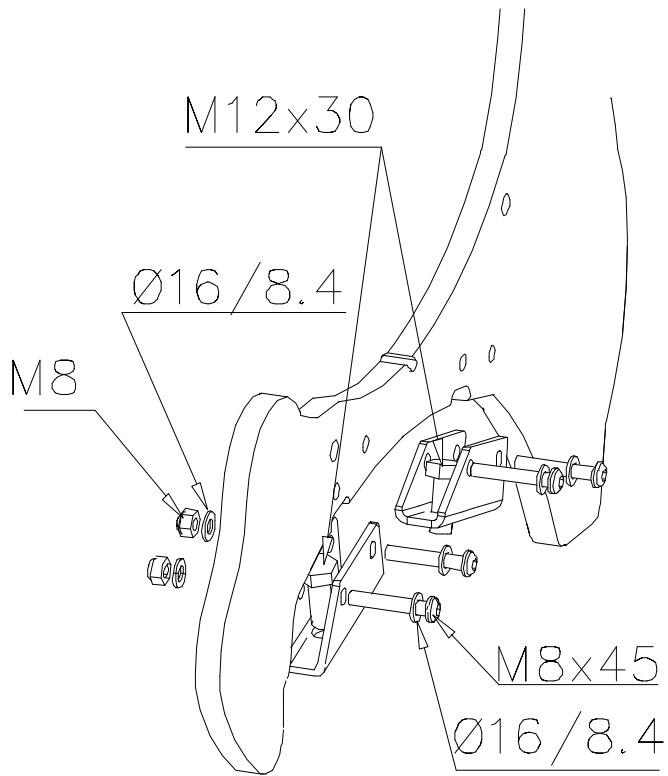

DET 2

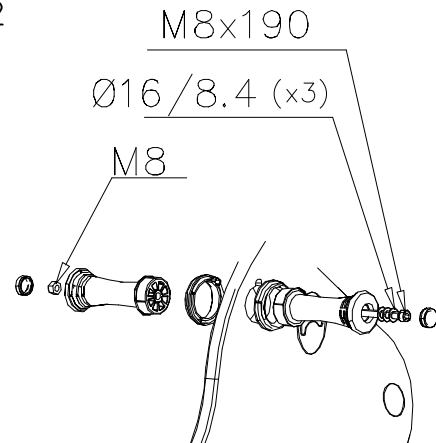

DET 3

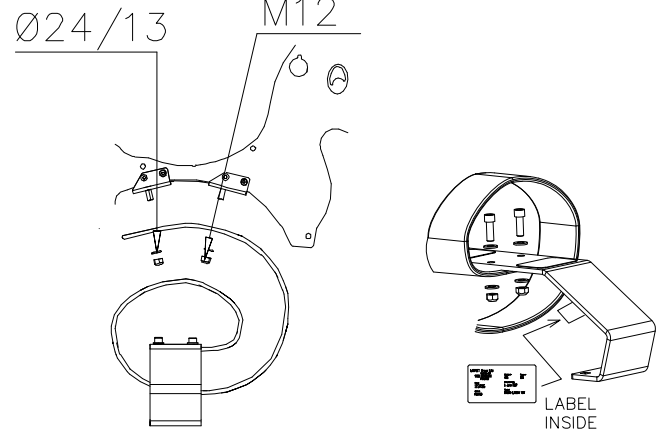



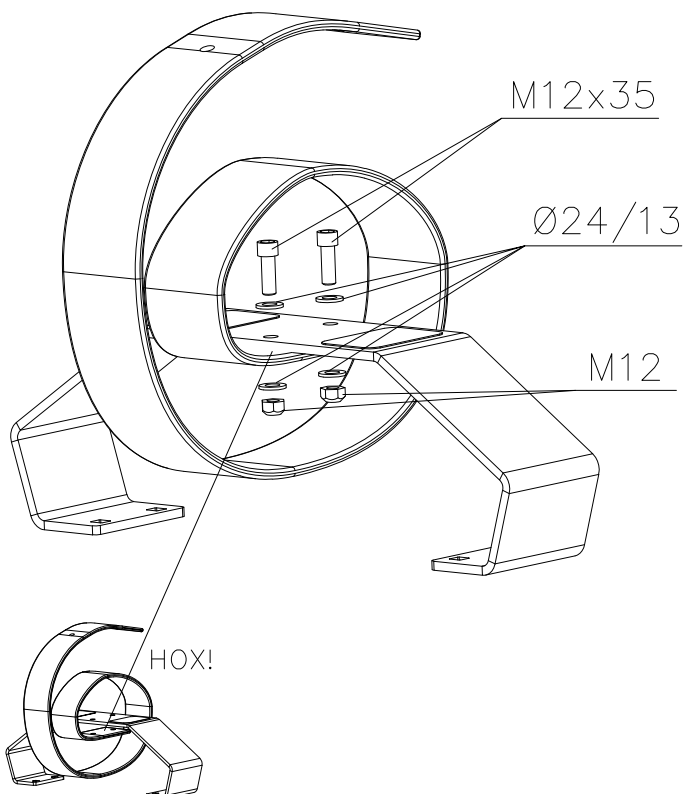



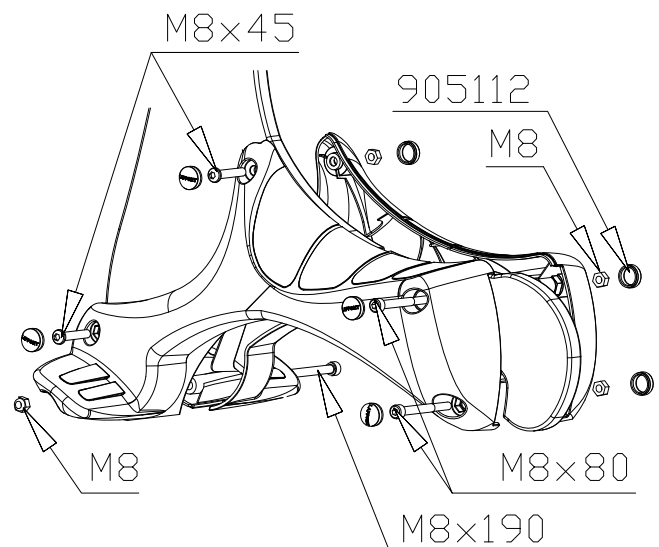



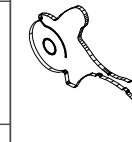

DET 4

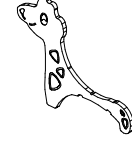

DET 5



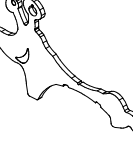
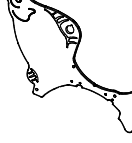







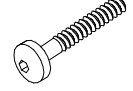



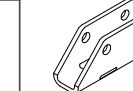
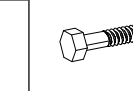
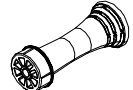

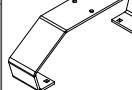
DATE: 15.4.2021

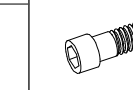
① 701988 (010501) 	PCS 1	① 701960 (010502) 	PCS 1	① 701991 (010503) 	PCS 1	① 702025 (010504) 	PCS 1	① 702023 (010505) 	PCS 1	① 702024 (010506) 	PCS 1
① 702028 (010507) 	PCS 1	① 702027 (010508) 	PCS 1	① 704435 (010509) 	PCS 1	① 704436 (010510) 	PCS 1	① 704437 (010511) 	PCS 1	① 706329 (010512) 	PCS 1
① 706331 (010513) 	PCS 1	① 707751 (010514) 	PCS 1	① 707571 (010516) 	PCS 1	① 710192 (Q41143) 	PCS 1				

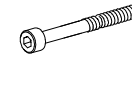
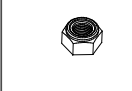
707014



② 901899 	PCS 6	③ 902095 	PCS 1	④ 902133 	PCS 1	⑤ 902211 	PCS 2	⑥ 902303 	PCS 2	⑦ 903149 	PCS 2
M8x45		RIGHT		LEFT						M12x30	
⑧ 905023 	PCS 2	⑨ 905032 	PCS 1	⑩ 905106 	PCS 1	⑪ 905112 	PCS 10	⑫ 906511 	PCS 4	⑬ 909146 	PCS 2
		8,5x90		590x190x120		Ø22		M12		M12x35	
⑭ 909195 	PCS 2	⑮ 909340 	PCS 2	⑯ 980150 	PCS 10	⑰ 980151 	PCS 11	⑱ 980154 	PCS 6		PCS
M8x190		M8x80		M8		Ø16/8.4		Ø24/13			

⑲ 702286 	PCS 1	
<div style="border: 1px solid black; padding: 2px; font-size: 8px;"> LAPPSET Group Ltd HANG HONG ST HO CHI MINH CITY VIETNAM TEL: +84 28 3511 1111 FAX: +84 28 3511 1112 WWW.LAPPSET.COM.VN </div>		
90x50		