

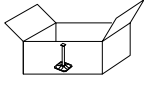





① 702286	PCS	② 706531	PCS
	1		4
90x50			
③ 707331	PCS	④ 707605	PCS
	4		2
93x93x470		21x1190x1190	
⑤ 707663	PCS	⑥ 902487	PCS
	1		1
		65x65	
⑦ 905138	PCS	⑧ 905196	PCS
	4		4
GRAY		GRAY	
⑨ 905821	PCS	⑩ 905829	PCS
	4		4
GRAY		STRAIGHT CLE	
⑪ 909506	PCS	⑫ 909511	PCS
	4		4
Ø3.5x13		90x90x650	
⑬ 909519	PCS	⑭ 980131	PCS
	4		16
50x380x380		Ø6x60	
	PCS		PCS

—— EN/AS Impact Area 13.8 m²
 - - - - Falling Space 13.8 m²
 Max Falling Height 980 mm

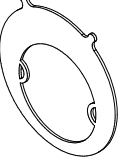
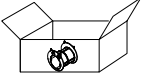
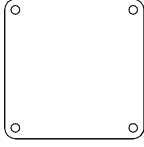
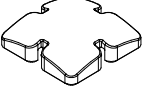
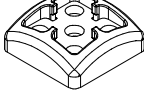
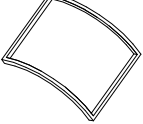
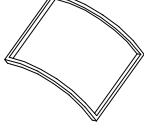
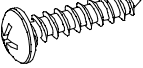
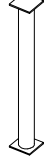
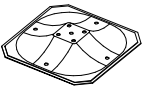
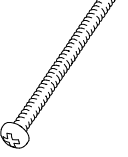
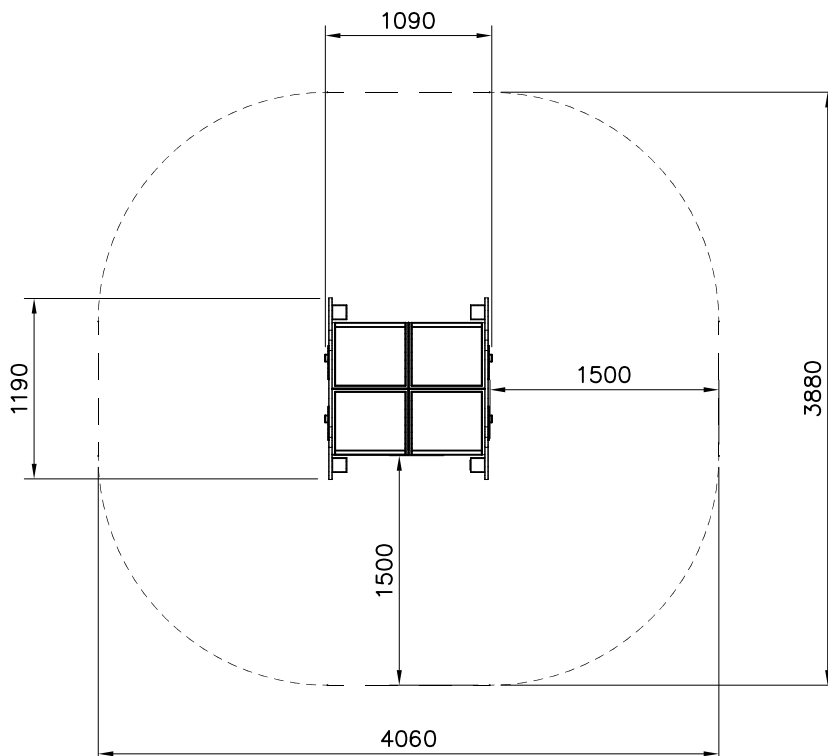
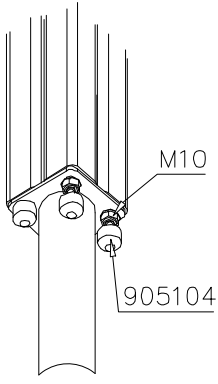
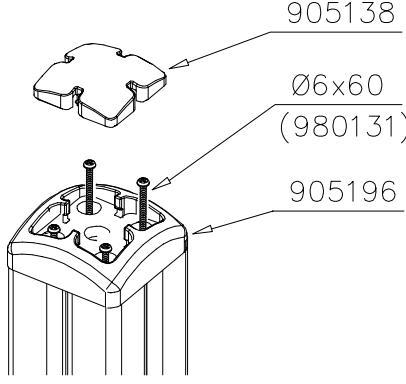
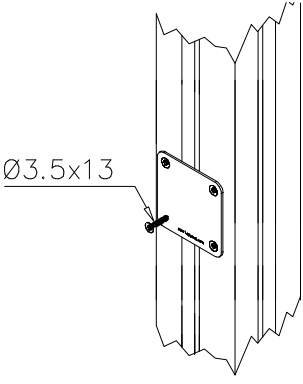
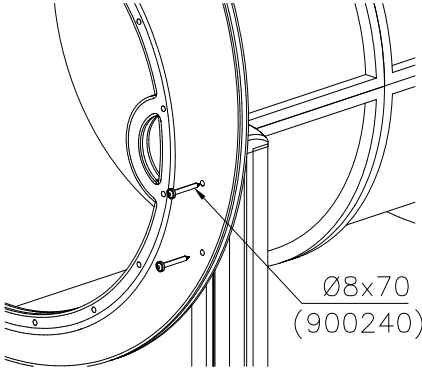
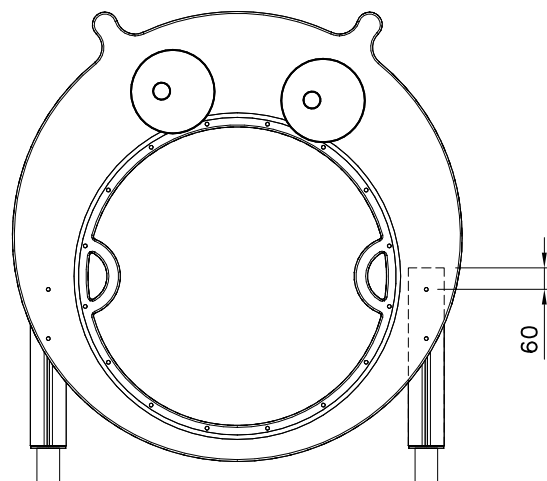
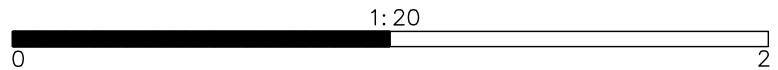

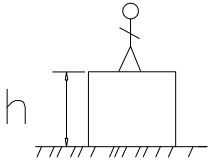
<p>DET 1</p> 	<p>DET 2</p> 	<p>DET 3</p> 
<p>DET 4</p> 		

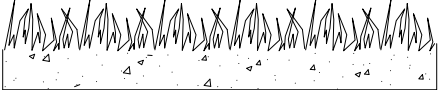
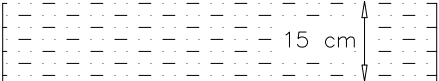
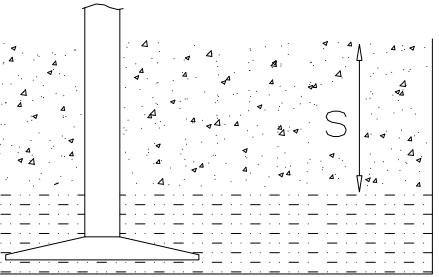
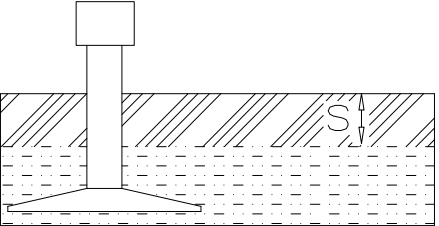

												
<p>$h < 600$</p> <p>Without movement and therefore without Impact Area</p>	<p>Totally hard surfaces.</p> <p>Note. Lappset does <u>not</u> recommend totally hard surfaces at all.</p>	<p>E.g. concrete or asphalt</p> 										
<p>$h < 600$</p> <p>With movement e.g. rocking</p>	<p>Materials with very limited impact attenuating properties.</p>	<p>E.g. wood</p> 										
<p>$h < 1000$</p>	<p>Materials with significant impact attenuating properties.</p>	<p>fine gravel 0–8 mm</p>  <p>grass</p>  <p>unsorted sand</p> 										
<p>$h < 3000$</p>	<p>Loose fill material</p> <p>E.g. sand/gravel 0,25...8 mm D60/D10<3,0 Woodchips 5...30 mm bark 20...80 mm</p>	 <table data-bbox="1024 1688 1326 1787"> <tr> <td>\underline{S}</td> <td>\underline{h}</td> </tr> <tr> <td>30 cm</td> <td>< 2,0 m</td> </tr> <tr> <td>40 cm</td> <td>< 3,0 m</td> </tr> </table>	\underline{S}	\underline{h}	30 cm	< 2,0 m	40 cm	< 3,0 m				
\underline{S}	\underline{h}											
30 cm	< 2,0 m											
40 cm	< 3,0 m											
	<p>Syntethic granulates</p> <table data-bbox="405 1899 751 2056"> <tr> <td>\underline{S}</td> <td>\underline{h}</td> </tr> <tr> <td>40 mm</td> <td>~> 1,2...1,3 m</td> </tr> <tr> <td>50 mm</td> <td>~> 1,5...1,7 m</td> </tr> <tr> <td>60 mm</td> <td>~> 1,8...2,0 m</td> </tr> <tr> <td>70 mm</td> <td>~> 2,1...2,5 m</td> </tr> </table> <p>Note. For accurate values, see manufacturer's instructions.</p>	\underline{S}	\underline{h}	40 mm	~> 1,2...1,3 m	50 mm	~> 1,5...1,7 m	60 mm	~> 1,8...2,0 m	70 mm	~> 2,1...2,5 m	
\underline{S}	\underline{h}											
40 mm	~> 1,2...1,3 m											
50 mm	~> 1,5...1,7 m											
60 mm	~> 1,8...2,0 m											
70 mm	~> 2,1...2,5 m											

REMOVE SAFETY SURFACE/SAND/GRAVEL
TO CHECK FOUNDATION

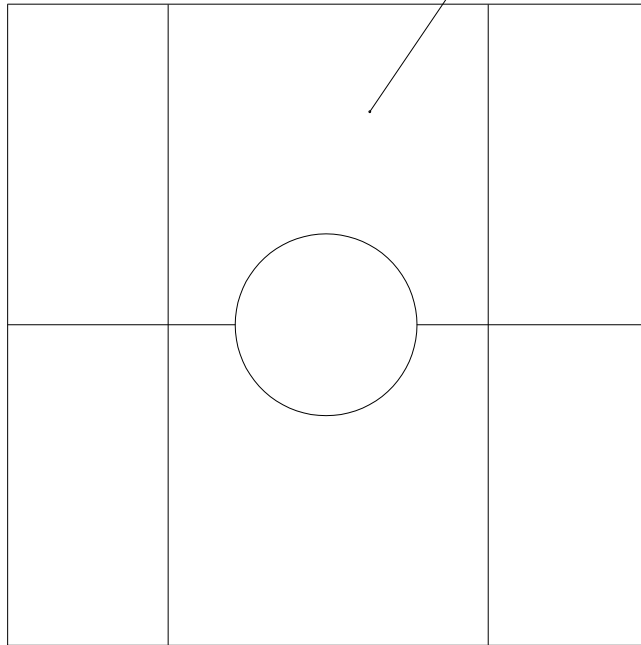

REMOVE SAFETY SURFACE/SAND/GRAVEL
TO CHECK FOUNDATION

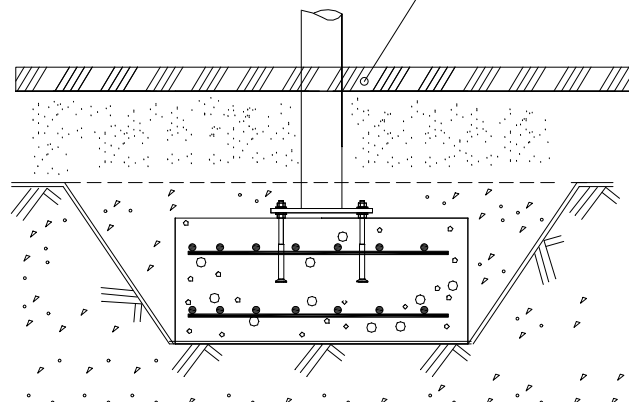

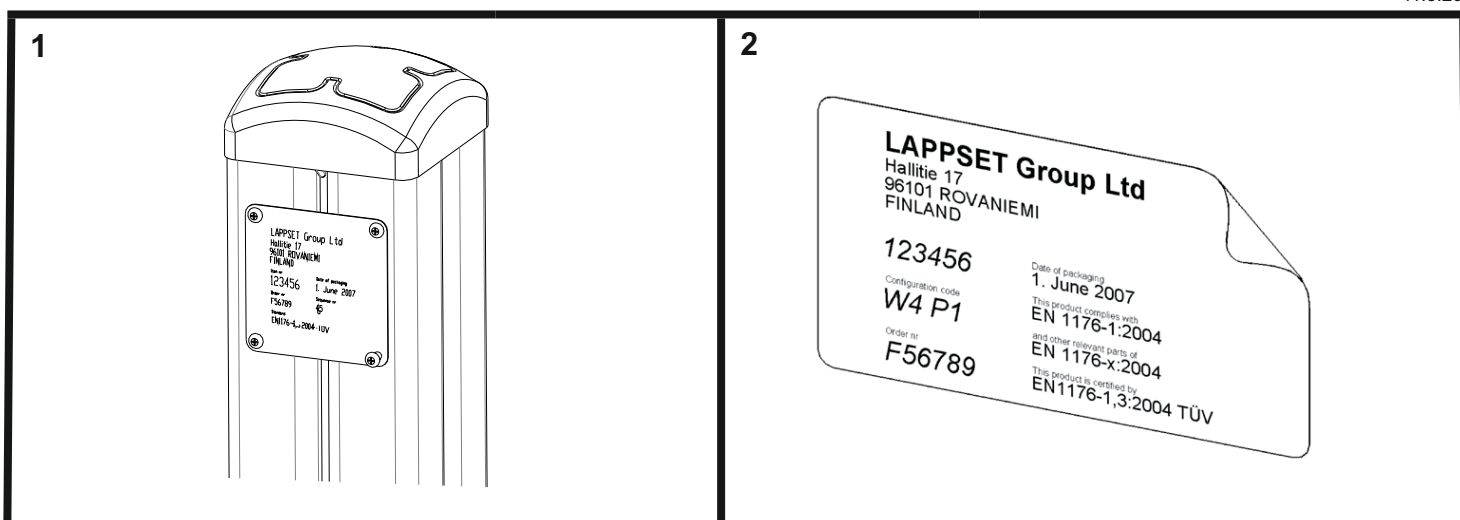

Tuotekyltti tulee tuotteen mukana yhdellä seuraavista tavoista:

1) Metallinen tuotekyltti ja kiinnitysruuvit

- Kiinnitä tuotekyltti ruuveilla tolppaan noin 2 metrin korkeuteen kuvan 2 mukaisesti.

2) Tuotekylttitarra

- Puhdista maalattu metalli- tai vaneripinta pölystä ja kosteudesta. Liimaa tarra kuvan 3 mukaisesti.
- Huom. Älä kiinnitä tarraa karheapintaiseen laminaattiin tai maalattuun puuhun.

Vår produktmärkning levereras på ett av följande sätt:

1) Produktskylt i metall

- Fäst skylten med de medföljande skruvarna

2) Självhäftande produktetikett

- Rengördenpulverlackerademetallytanellerlaminatytansåttndenblirfrifrånsmutsochfukt.Fästetikettenenligtfig.3.
- Obs! Fäst ej etiketten på detaljer med skrovlig yta eller på målat trä.

Product label is delivered by one of following ways:

1) Metal product label and screws

- Fasten the label with screws.

2) Label sticker

- Cleanthepaintedmetalorplywoodsurfacefromdirtandmoisture.Fastenthestickerasshowninthefigure3.
- Note. Do not attach the sticker to rough surfaced laminate or painted wood.

La plaque d'informations produit est livrée sous l'une de ces 3 formes :

1) Plaque métallique et vis

- Fixez la plaque à l'aide des vis.

2) Etiquette autocollante

- Avant de coller l'étiquette, nettoyez le composant métallique peint ou la plaque de contreplaqué, de toute saleté. La surface doit être sèche (voir image 3).
- Attention, ne pas coller l'étiquette sur une surface lamellé-collée irrégulière ou sur du bois peint.

Die Auslieferung des Produktaufklebers erfolgt auf eine dieser Arten:

1) Produkt-Schild aus Metall incl. Schrauben

- Die Befestigung des Schildes erfolgt mittels der Schrauben.

2) Aufkleber

- EntfernenSiezunächstSchmutzundFeuchtigkeitvomlackiertenMetallbzw.vonderHolzoberflächeundbringenSiedenAufkleber wie im Bild oben rechts beschrieben auf den gesäuberten Untergrund auf.
- Beachten Sie: Bringen Sie den Aufkleber nicht auf raues laminiertes oder lackiertes Holz an.

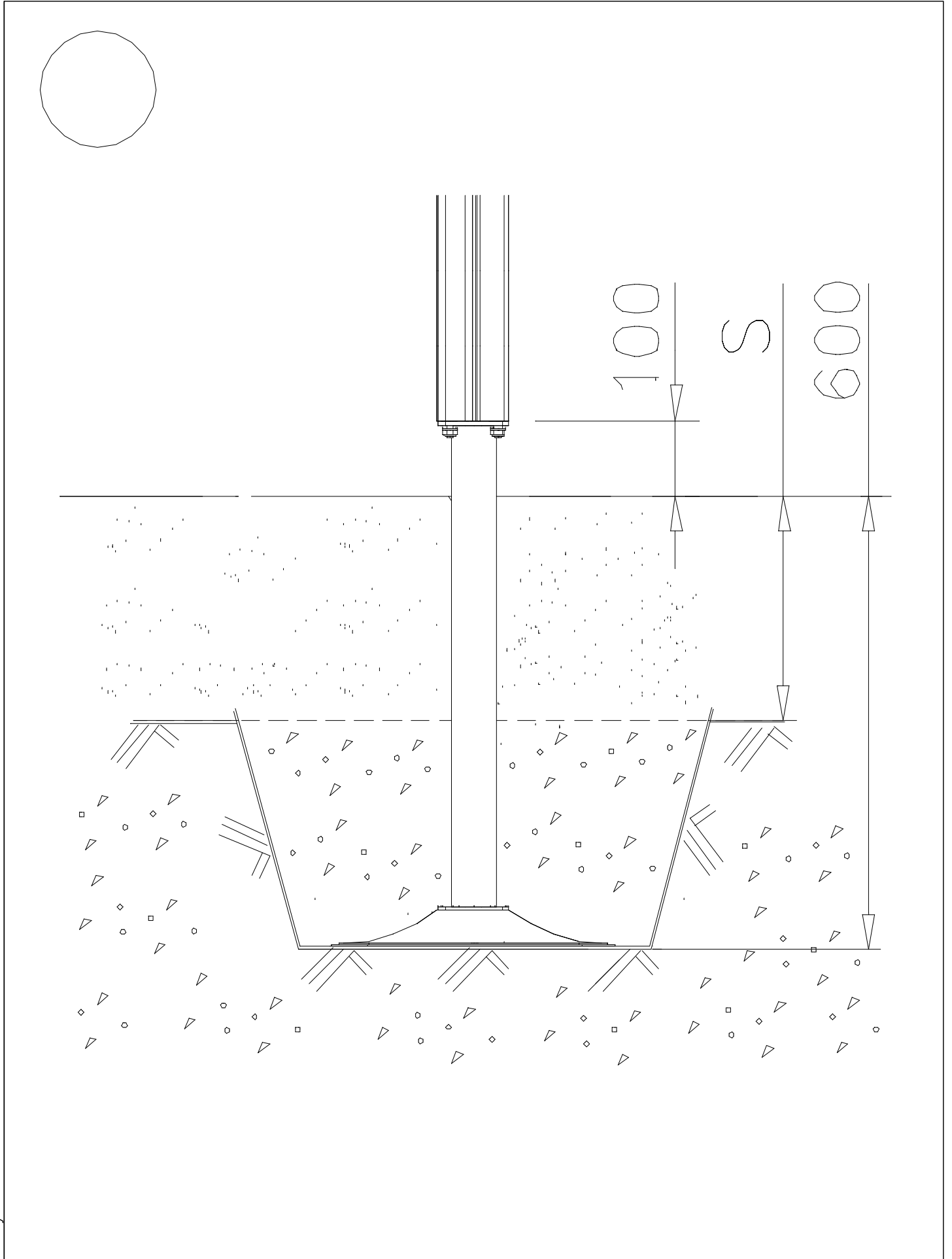

WINAM GROUP BETON FOUNDATION

FOOT

DATE: 27.10.2015

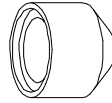

② 905104	PCS		PCS
	4		
 M10			
	PCS		PCS

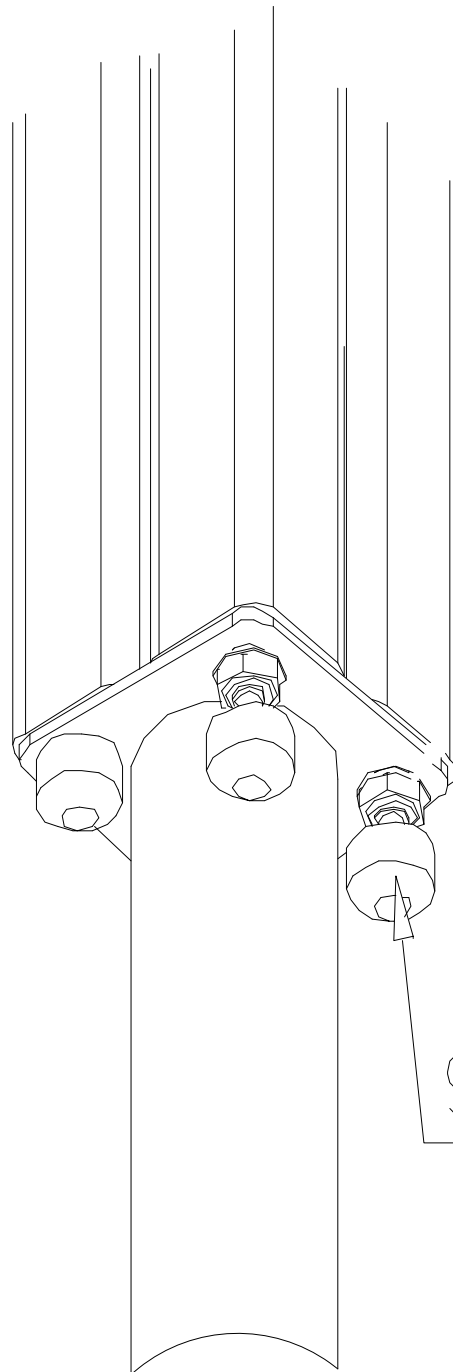

905104

WINAM GROUP DEEP FOUNDATION





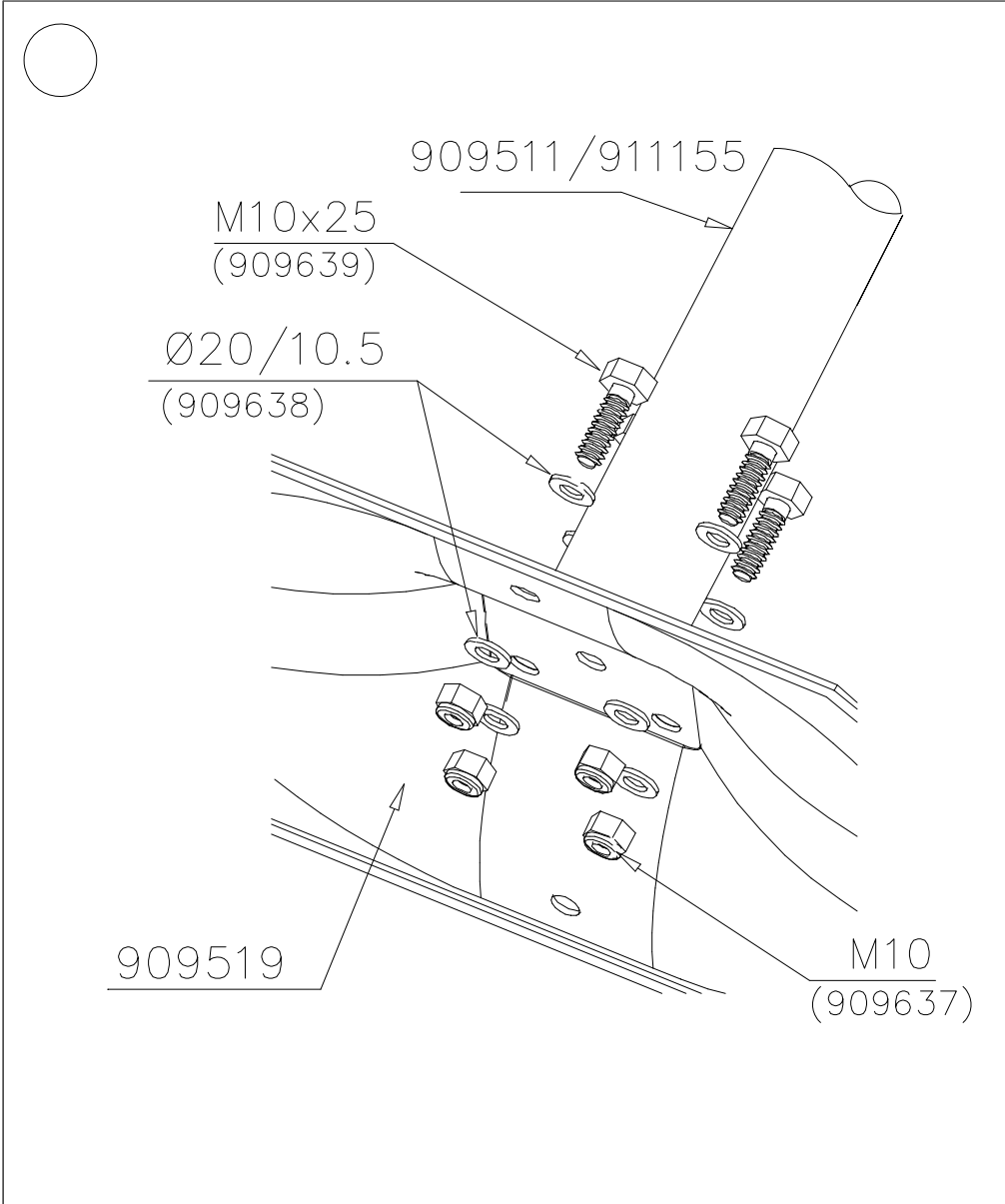



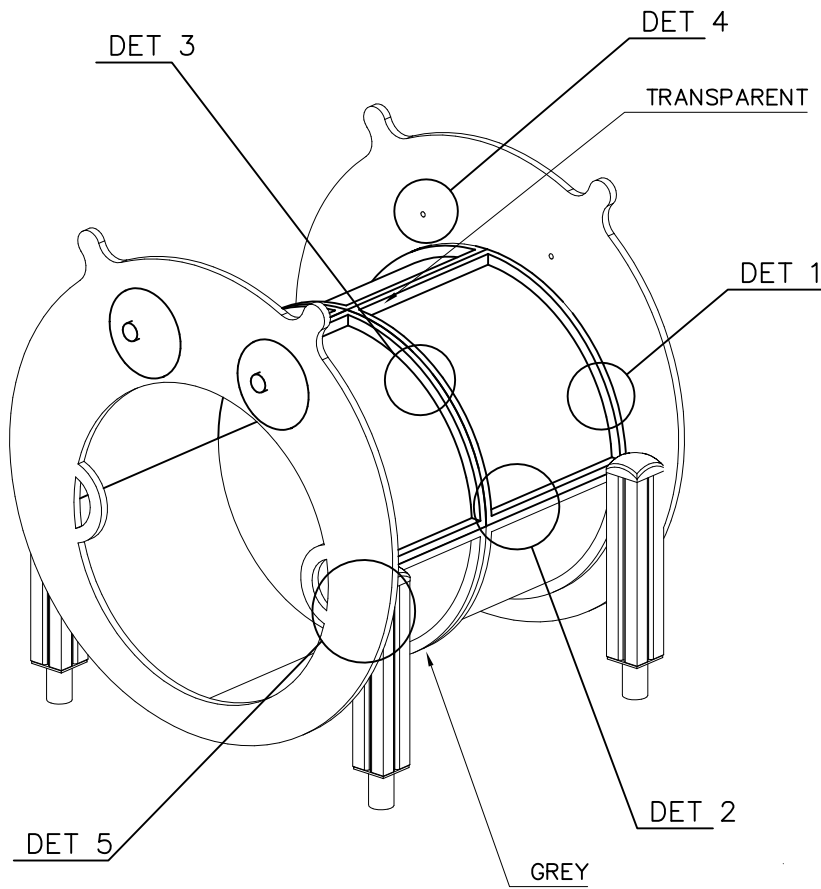

FOOT

DATE: 15.5.2018



① 909511	PCS	② 909519	PCS
	1		1
90x90x650		50x380x380	
③ 909637	PCS	④ 909638	PCS
	4		8
M10		Ø20/10.5	
⑤ 909639	PCS	⑥ 905104	PCS
	4		4
M10x25		M10	
OPTION FOOT			
① 911155	PCS		PCS
	1		
90x90x650			

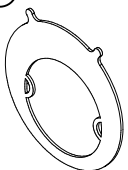
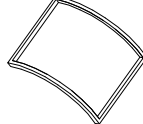
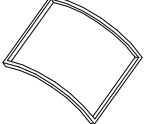

①	905831	PCS	②	909866	PCS
		112			32
					
	Ø32x19			M8x60	
③	909205	PCS	④	909208	PCS
		40			32
					
	M8x60			M8	
⑤	980150	PCS	⑥	905112	PCS
		40			112
					
	M8			Ø22	
⑦	900240	PCS	⑧	905090	PCS
		8			4
					
	Ø8x70			Ø45	
⑨	902234	PCS	⑩	900367	PCS
		4			4
					
	M12			M12x40	
⑪	905115	PCS			PCS
		4			
					
	Ø30				
		PCS	○	707605	PCS
					2
					
				21x1190x1190	
○	905821	PCS	○	905829	PCS
		4			4
					
	GRAY			STRAIGHT CLE	

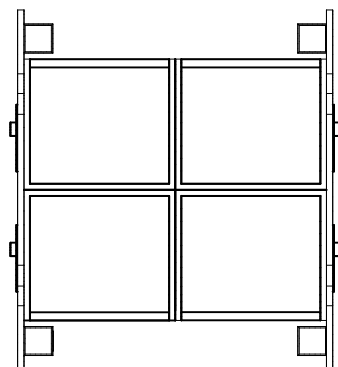

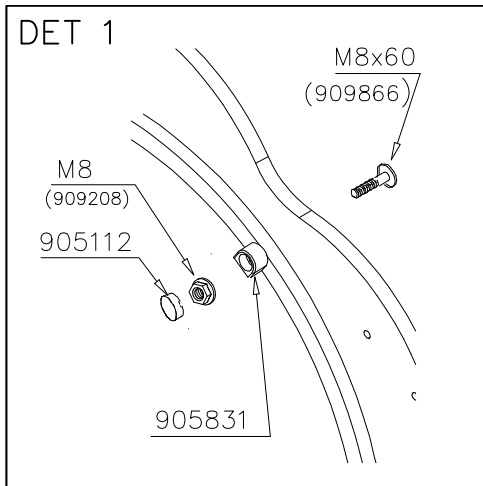
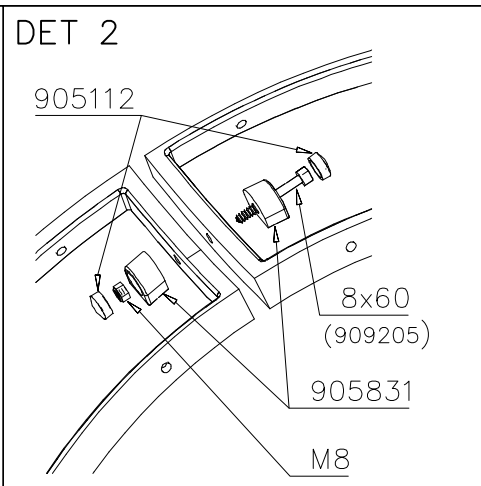
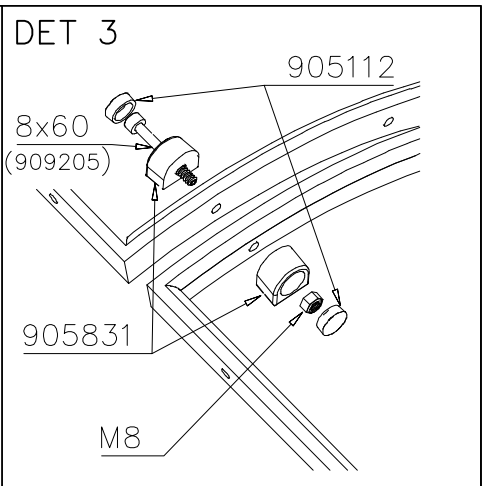
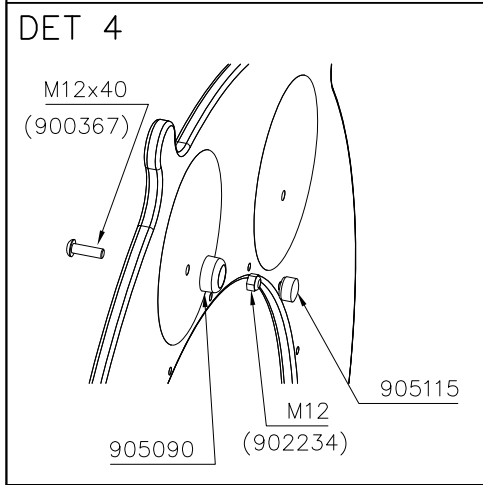
<p>DET 1</p>  <p>M8 (909208) 905112 M8x60 (909866) 905831</p>	<p>DET 2</p>  <p>905112 8x60 (909205) 905831 M8</p>	<p>DET 3</p>  <p>905112 8x60 (909205) 905831 M8</p>
<p>DET 4</p>  <p>M12x40 (900367) 905090 M12 (902234) 905115</p>		