

# WINAM GROUP

## FITNESS



ASENNUSOHJE  
MONTERINGSANSVISNING  
INSTALLATION INSTRUCTION  
AUFBAUANLEITUNG  
NOTICE D'INSTALLATION

DATE: 26.5.2020

Fitness equipment is not intended for installation in the immediate vicinity of children's playgrounds in accordance with EN 1176.





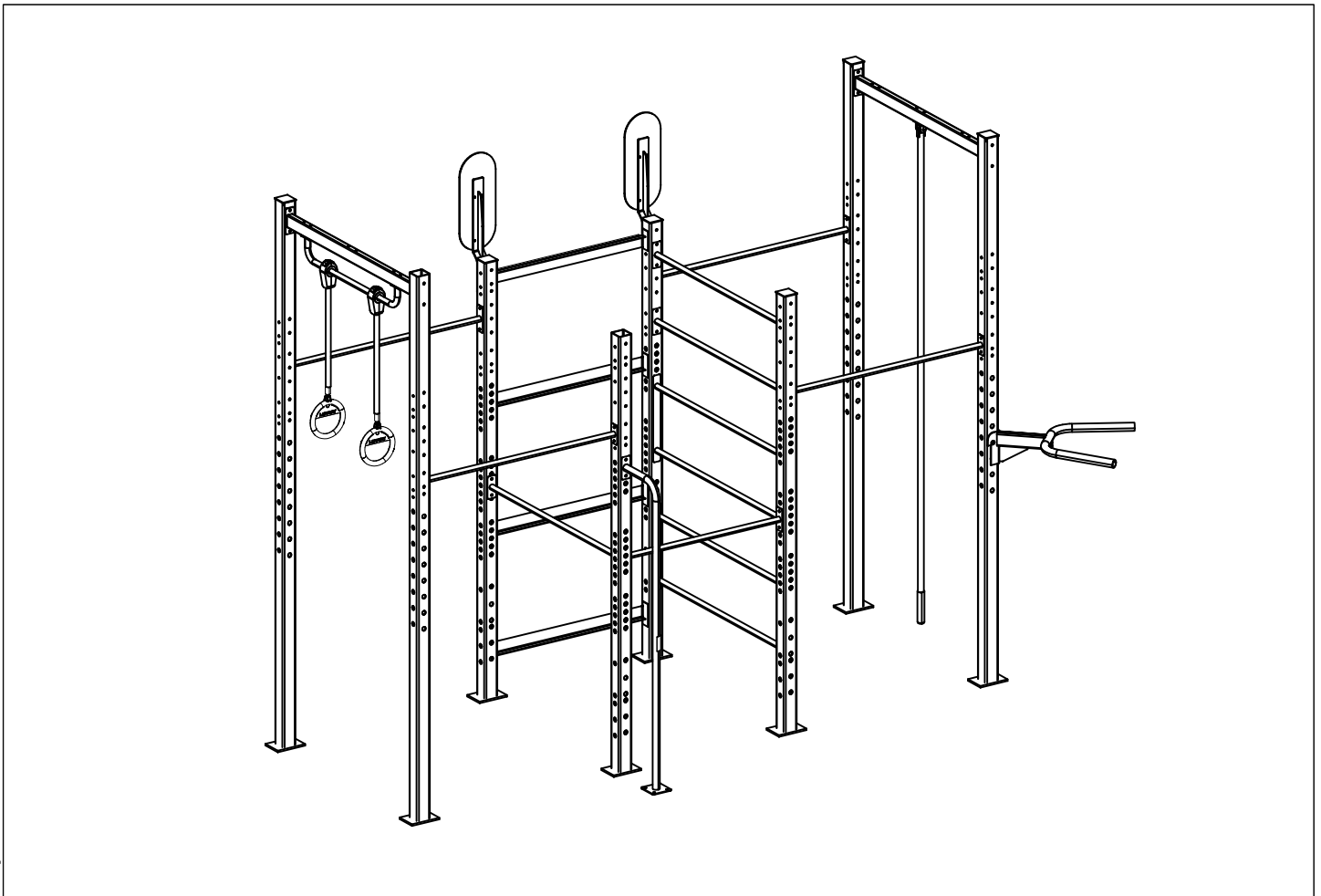







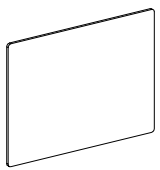
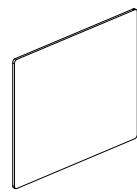
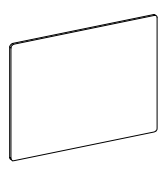

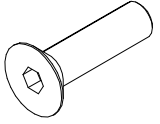

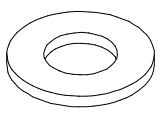
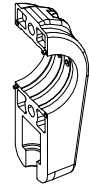
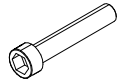
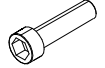

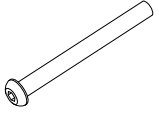
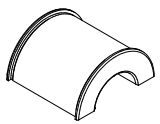

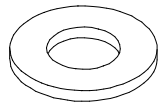

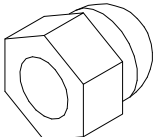
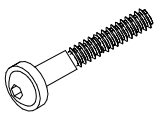
Kuntolaitteita ei ole tarkoitettu asennettaviksi lasten leikkikentän välittömään läheisyyteen standardin EN 1176 mukaisesti.

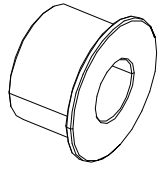
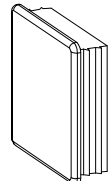
# 081850

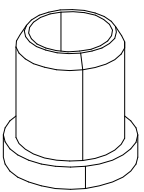
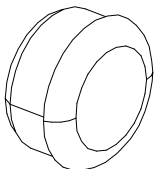
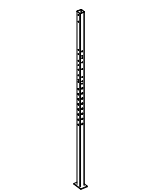
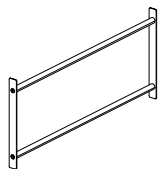

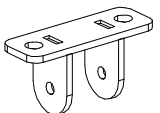
## FITNESS

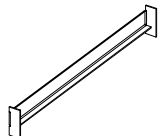
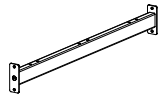
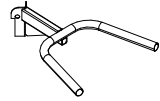
DATE: 26.5.2020

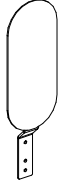
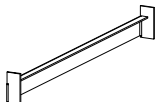
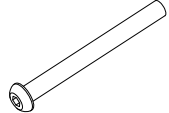
<p>702341</p>  <p>90x50</p>	<p>PCS</p> <p>1</p>	<p>705039</p>  <p>Ø16x974</p>	<p>PCS</p> <p>2</p>	<p>708799-704</p>  <p>15x1050x798</p>	<p>PCS</p> <p>1</p>	<p>708800-704</p>  <p>15x1050x798</p>	<p>PCS</p> <p>1</p>	<p>708801-704</p>  <p>15x1050x798</p>	<p>PCS</p> <p>1</p>	<p>708811</p>  <p>Ø32x3050</p>	<p>PCS</p> <p>1</p>
<p>900348</p>  <p>M8x30</p>	<p>PCS</p> <p>24</p>	<p>900965</p>  <p>M10</p>	<p>PCS</p> <p>88</p>	<p>901302</p>  <p>Ø20/10.5x2</p>	<p>PCS</p> <p>134</p>	<p>902195</p>  <p>150x50x50</p>	<p>PCS</p> <p>4</p>	<p>902232</p>  <p>M10x55</p>	<p>PCS</p> <p>2</p>	<p>902233</p>  <p>M10x30</p>	<p>PCS</p> <p>2</p>
<p>904450</p>  <p>M16x170</p>	<p>PCS</p> <p>32</p>	<p>904917</p>  <p>M10x100</p>	<p>PCS</p> <p>6</p>	<p>906006</p>  <p>Ø64/36,4x59</p>	<p>PCS</p> <p>4</p>	<p>906598</p>  <p>366x50</p>	<p>PCS</p> <p>1</p>	<p>909256</p>  <p>Ø16/8.4x1.6</p>	<p>PCS</p> <p>29</p>	<p>909628</p>  <p>M10x100</p>	<p>PCS</p> <p>4</p>
<p>909633</p>  <p>M8</p>	<p>PCS</p> <p>25</p>	<p>909867</p>  <p>M8x70</p>	<p>PCS</p> <p>1</p>	<p>910368-217</p>  <p>1315</p>	<p>PCS</p> <p>2</p>	<p>910376</p>  <p>Ø30x17</p>	<p>PCS</p> <p>72</p>	<p>910405</p>  <p>90x90x30</p>	<p>PCS</p> <p>8</p>	<p>910410-207</p>  <p>90x90x2720</p>	<p>PCS</p> <p>4</p>
<p>910415</p>  <p>Ø16/12,5-14x17</p>	<p>PCS</p> <p>208</p>	<p>910416</p>  <p>Ø48/43-45x24</p>	<p>PCS</p> <p>2</p>	<p>910427-207</p>  <p>90x90x3400</p>	<p>PCS</p> <p>4</p>	<p>910442-217</p>  <p>1315</p>	<p>PCS</p> <p>2</p>	<p>910444-217</p>  <p>1315x160</p>	<p>PCS</p> <p>4</p>	<p>910447-217</p> 	<p>PCS</p> <p>1</p>
<p>910448-207</p>  <p>110x38x55</p>	<p>PCS</p> <p>1</p>	<p>910455-217</p> 	<p>PCS</p> <p>1</p>	<p>910459-217</p>  <p>1060</p>	<p>PCS</p> <p>1</p>	<p>910604-217</p>  <p>1060</p>	<p>PCS</p> <p>3</p>	<p>910614-207</p>  <p>1315</p>	<p>PCS</p> <p>2</p>	<p>910619-217</p>  <p>45°</p>	<p>PCS</p> <p>1</p>
<p>910622-217</p>  <p>1315</p>	<p>PCS</p> <p>1</p>	<p>910625</p> 	<p>PCS</p> <p>2</p>	<p>910626-207</p>  <p>1060</p>	<p>PCS</p> <p>1</p>	<p>911149</p>  <p>M10x110</p>	<p>PCS</p> <p>78</p>		<p>PCS</p>		<p>PCS</p>

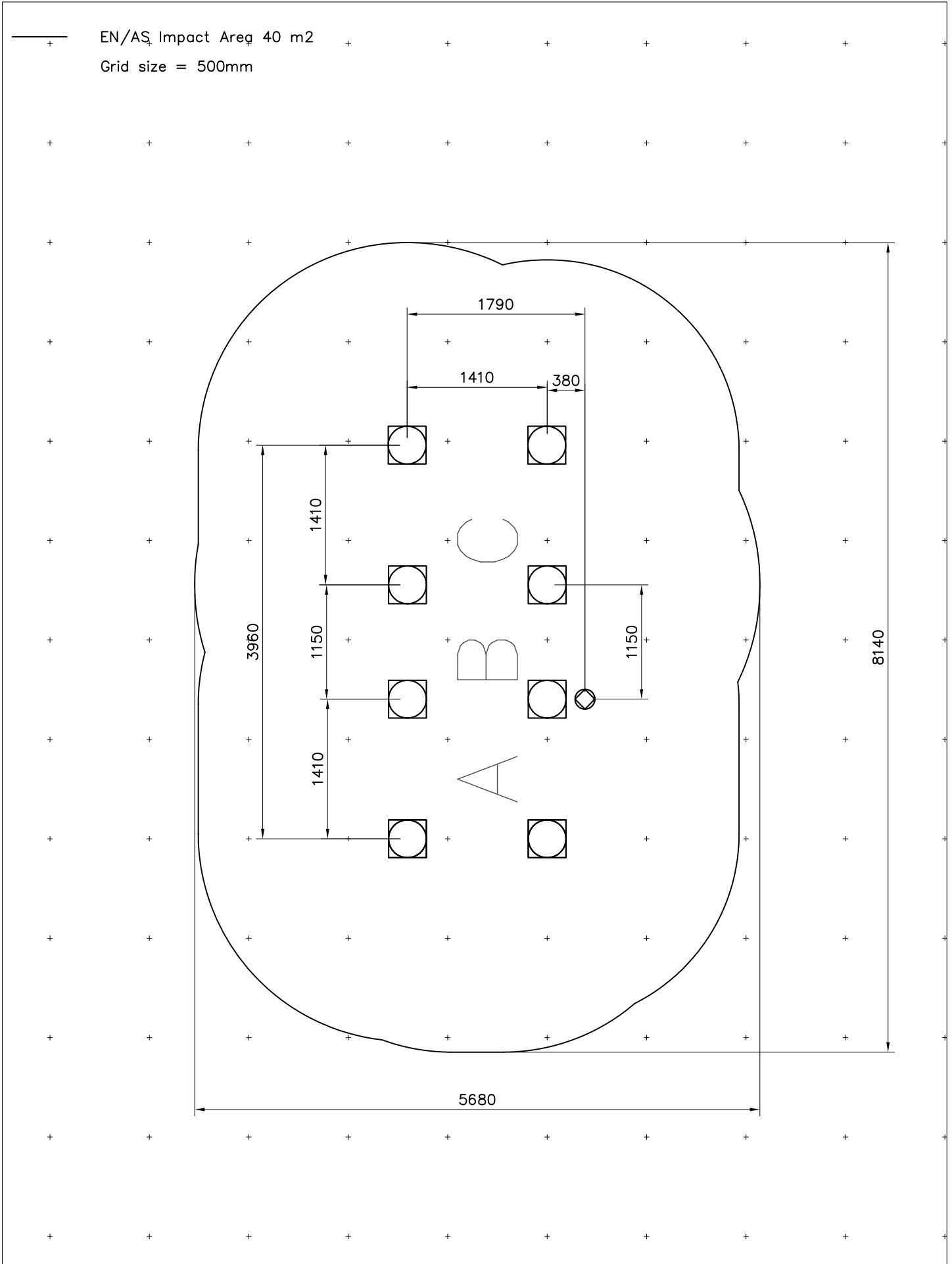

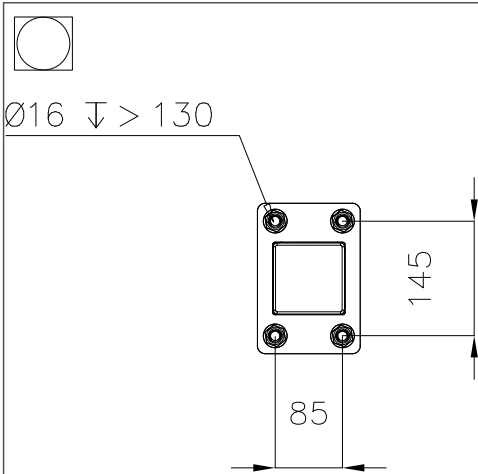
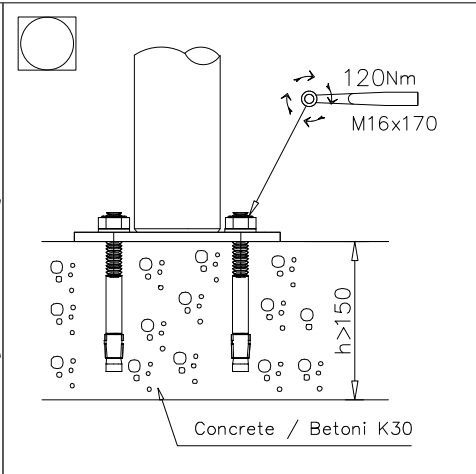
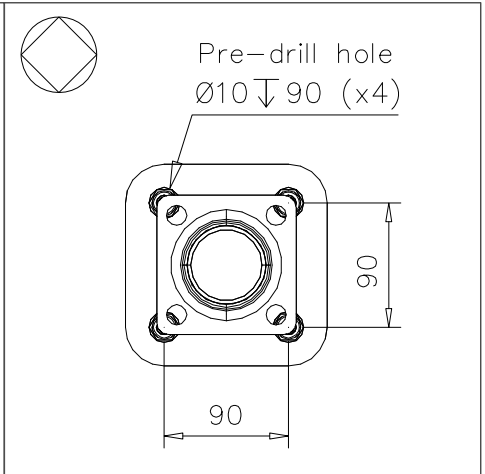
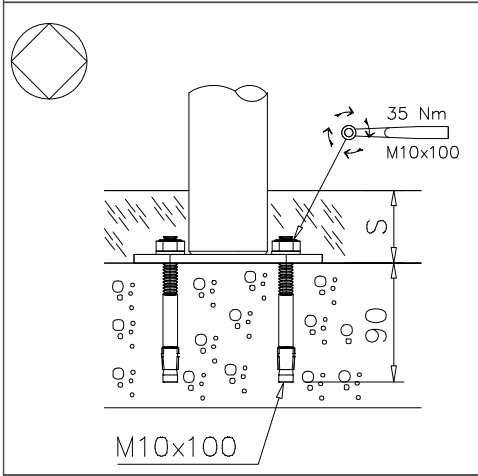
 <p>Ø16 ↓ &gt; 130</p> <p>145</p> <p>85</p>	 <p>120Nm</p> <p>M16x170</p> <p>h &gt; 150</p> <p>Concrete / Betoni K30</p>	 <p>Pre-drill hole Ø10 ↓ 90 (x4)</p> <p>90</p> <p>90</p>
 <p>35 Nm</p> <p>M10x100</p> <p>S</p> <p>90</p> <p>M10x100</p>		

Concrete foundation plans  
1pcs 200x500x4500  
1pcs 200x500x4500 + extension 330x430

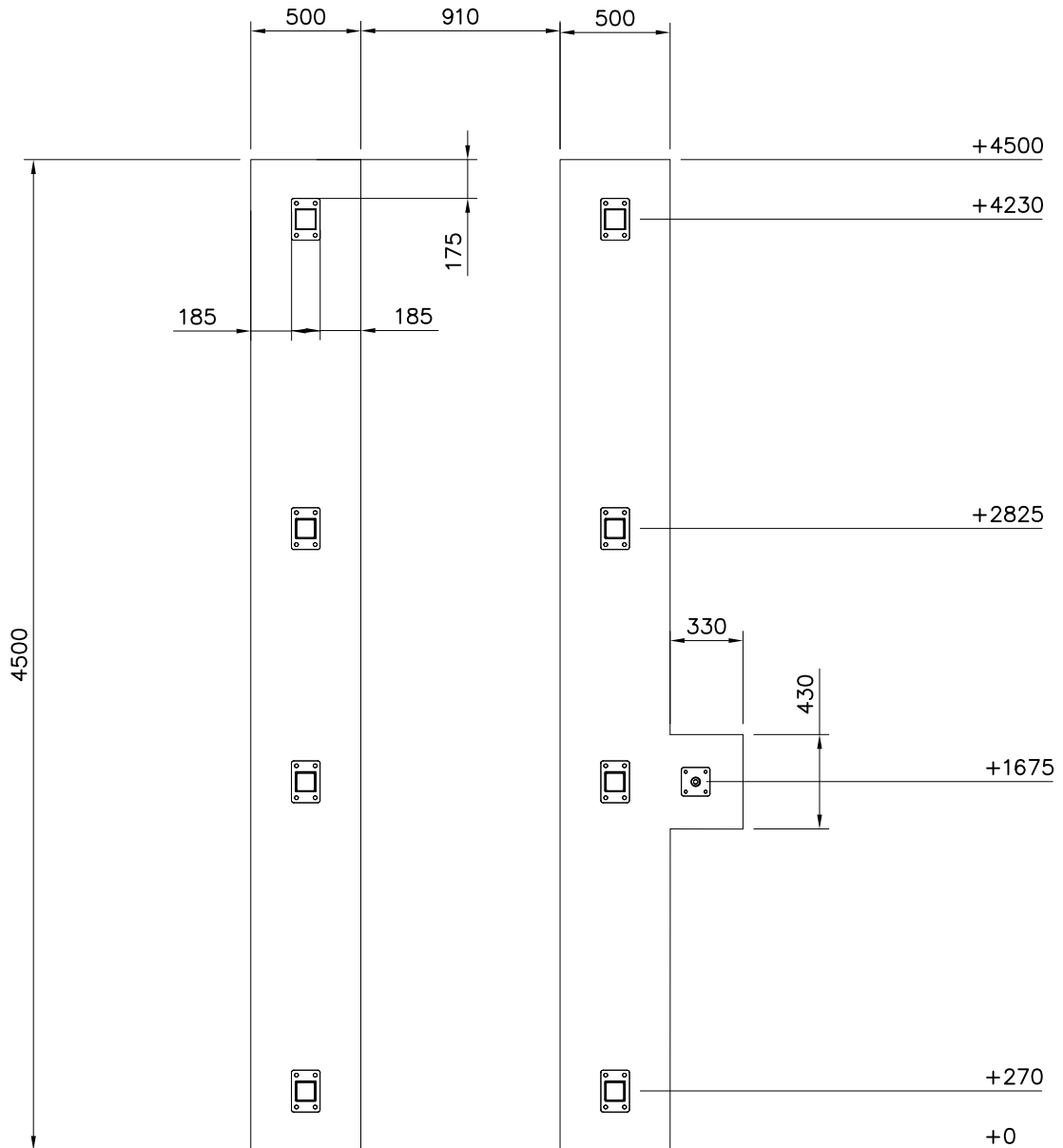

## FITNESS

DATE: 26.5.2020

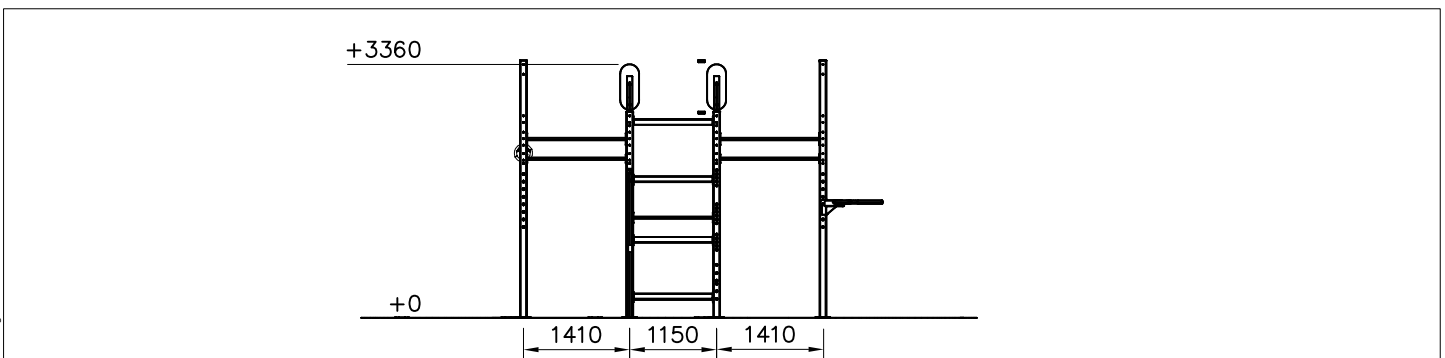
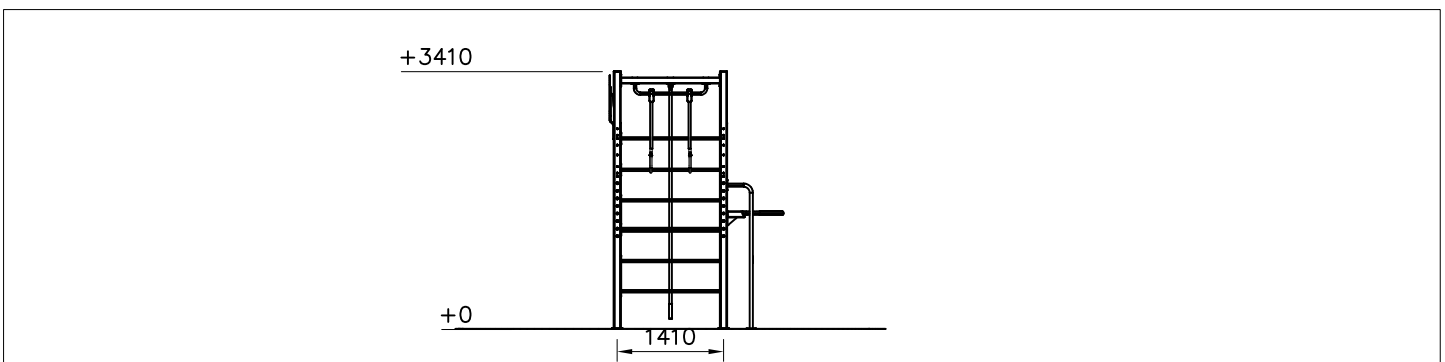
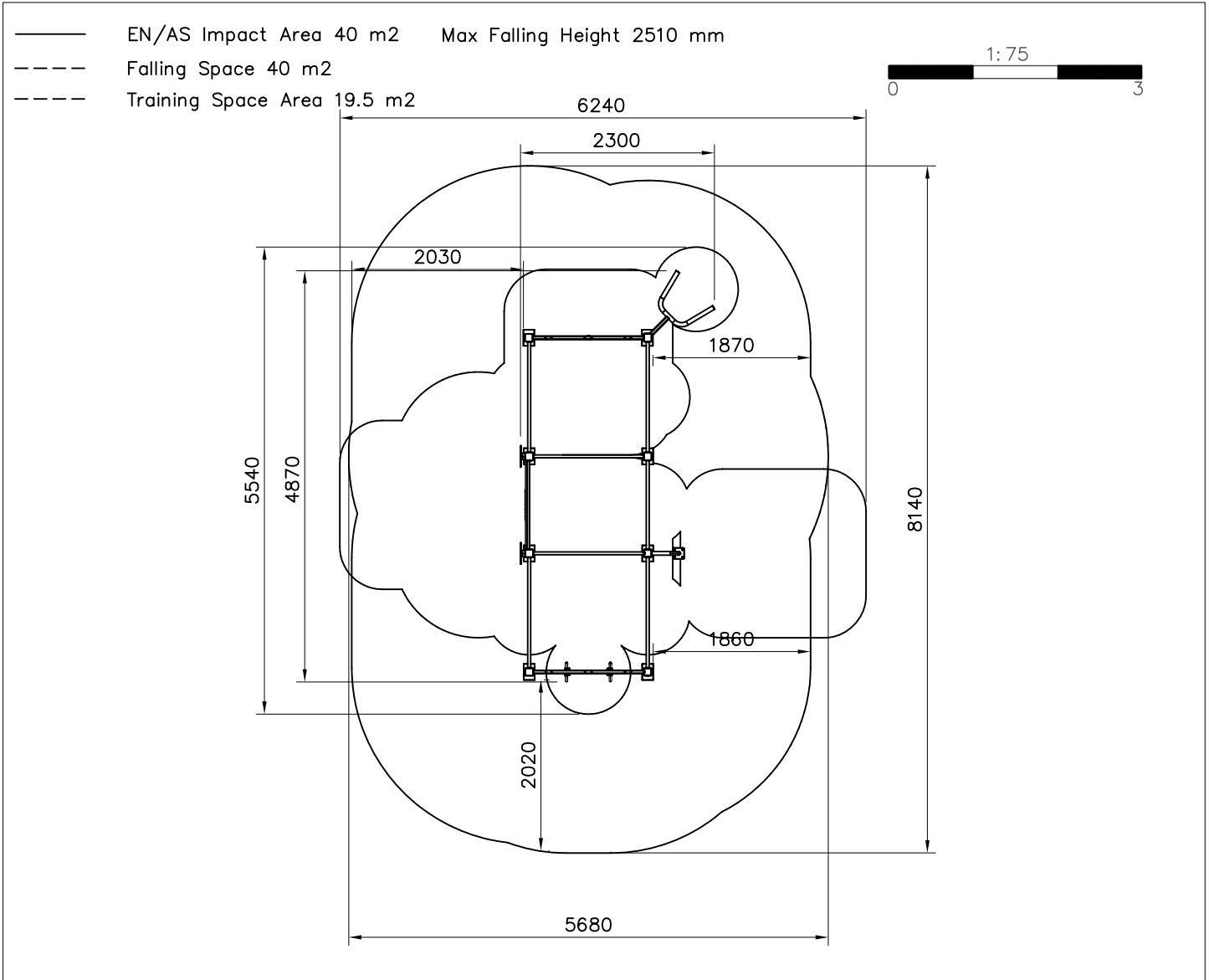

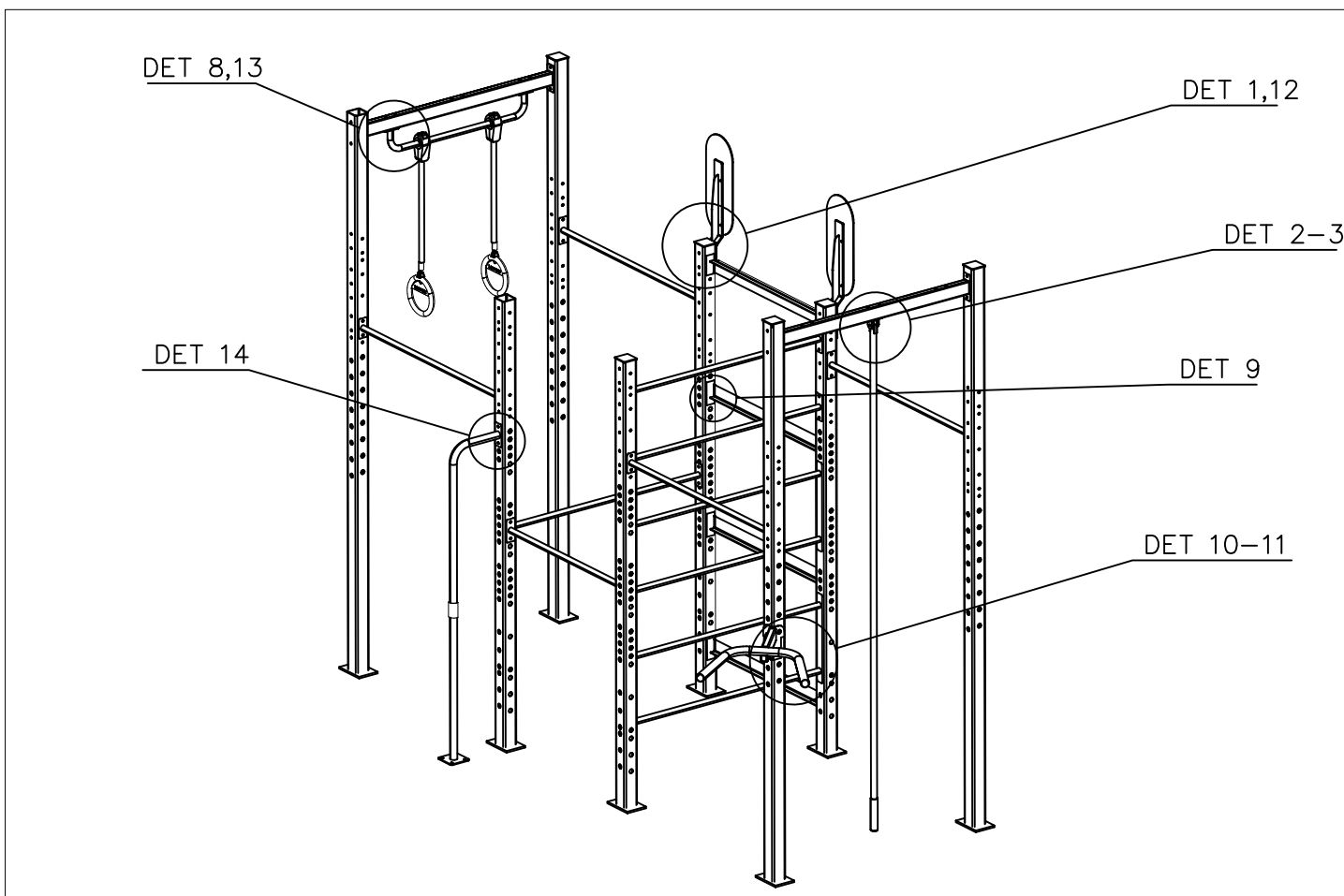
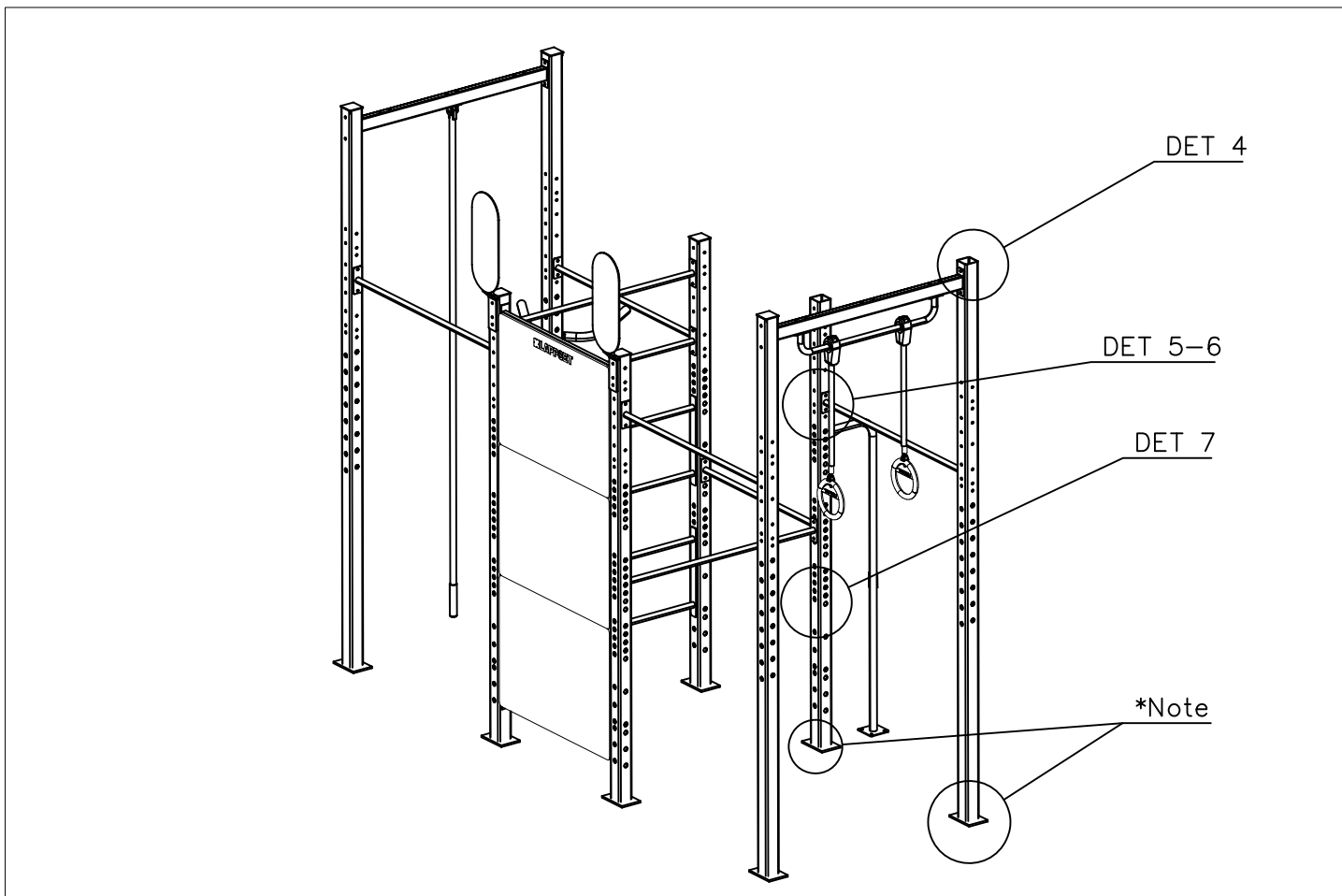

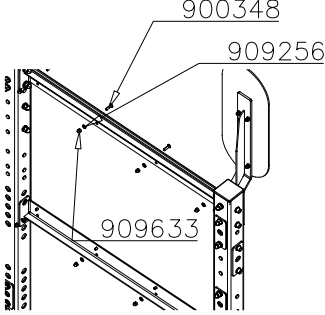
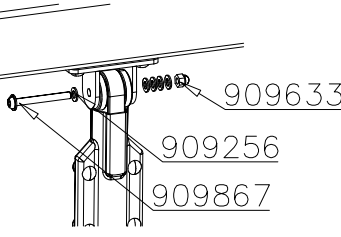
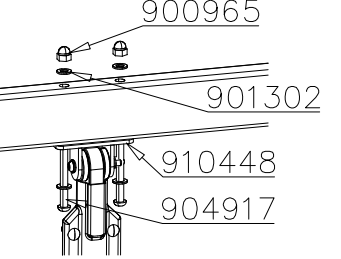
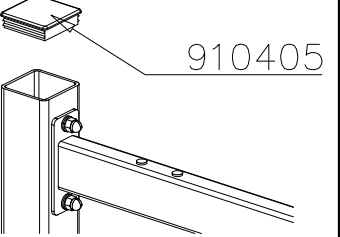
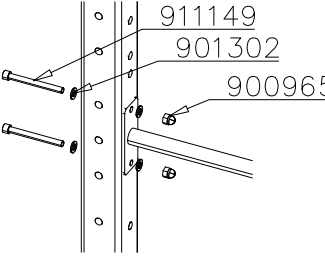
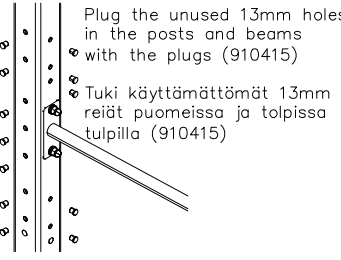
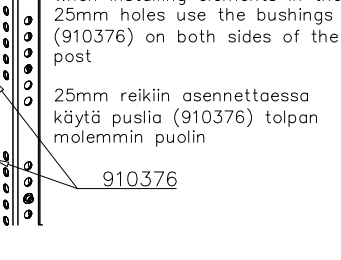
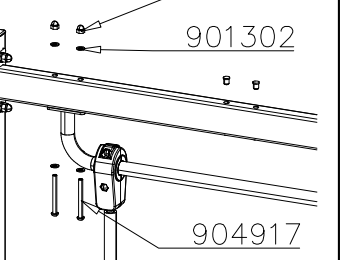
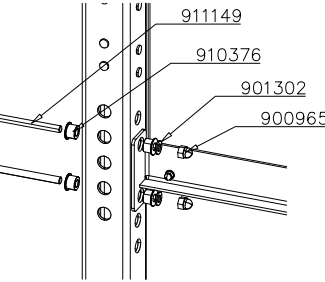
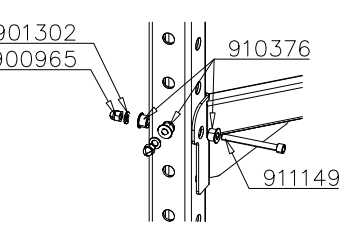
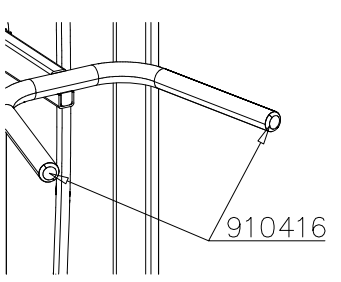
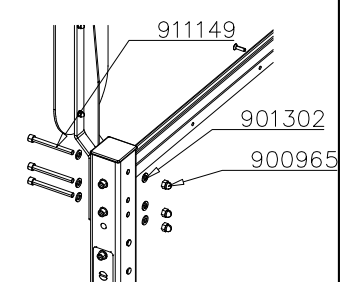
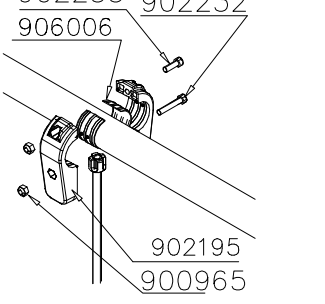
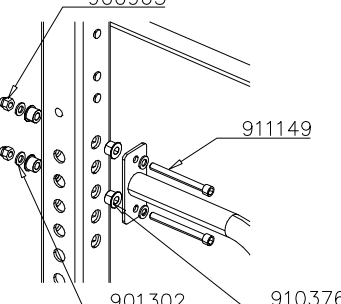
<p>DET 1</p> 	<p>DET 2</p> 	<p>DET 3</p> 	<p>DET 4</p> 
<p>DET 5</p> 	<p>DET 6</p> <p>Plug the unused 13mm holes in the posts and beams with the plugs (910415)</p> <p>Tuki käyttämättömät 13mm reiät puomeissa ja tulpissa tulpilla (910415)</p> 	<p>DET 7</p> <p>When installing elements in the 25mm holes use the bushings (910376) on both sides of the post</p> <p>25mm reikiin asennettaessa käytä puslia (910376) tolpan molemmin puolin</p> 	<p>DET 8</p> 
<p>DET 9</p> 	<p>DET 10</p> 	<p>DET 11</p> 	<p>DET 12</p> 
<p>DET 13</p> 	<p>DET 14</p> 	<p>*Note</p> <p>All the post flanges are in the same direction</p> <p>Kaikki pylväiden jalat ovat samansuuntaisesti</p>	



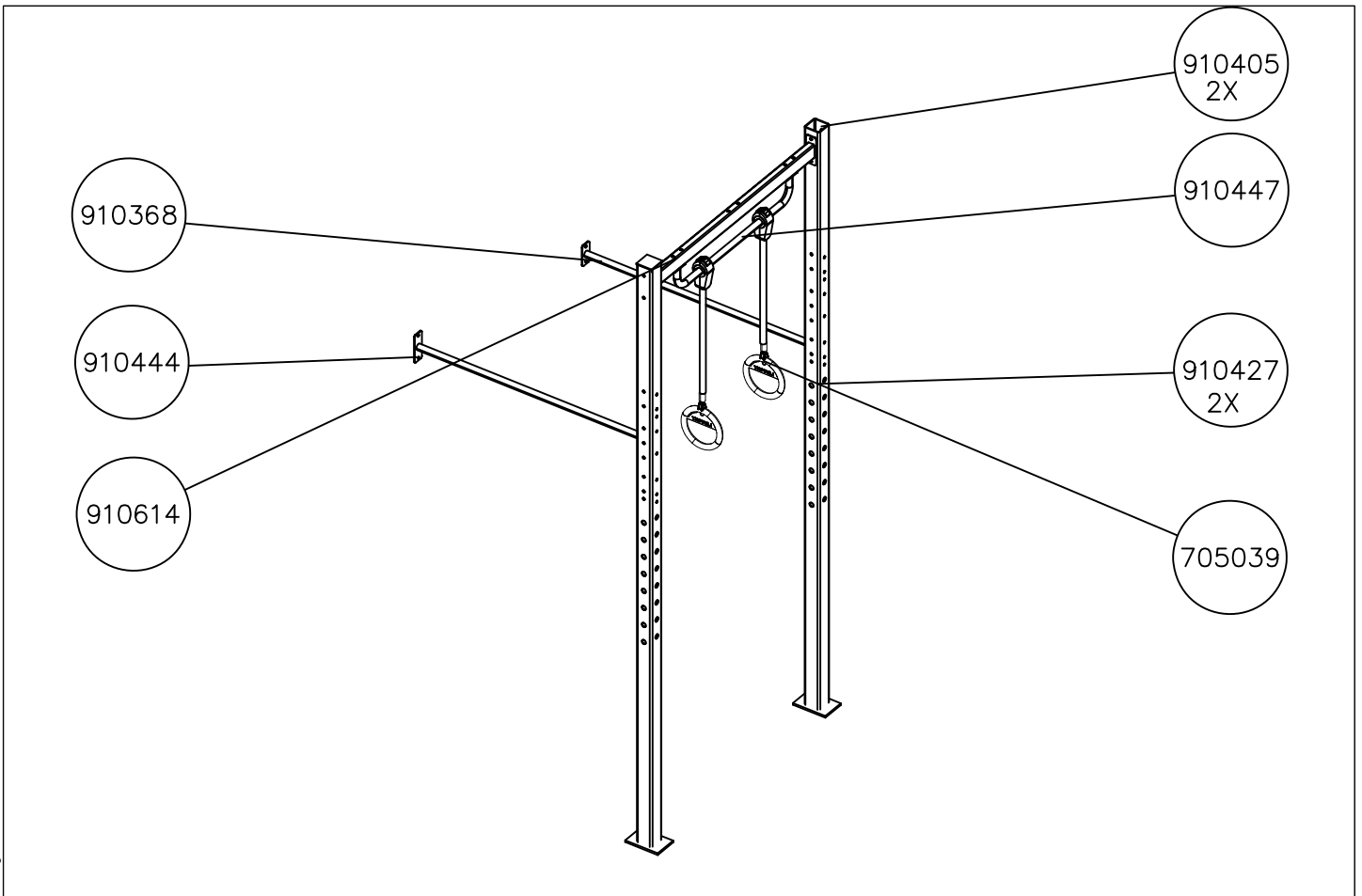
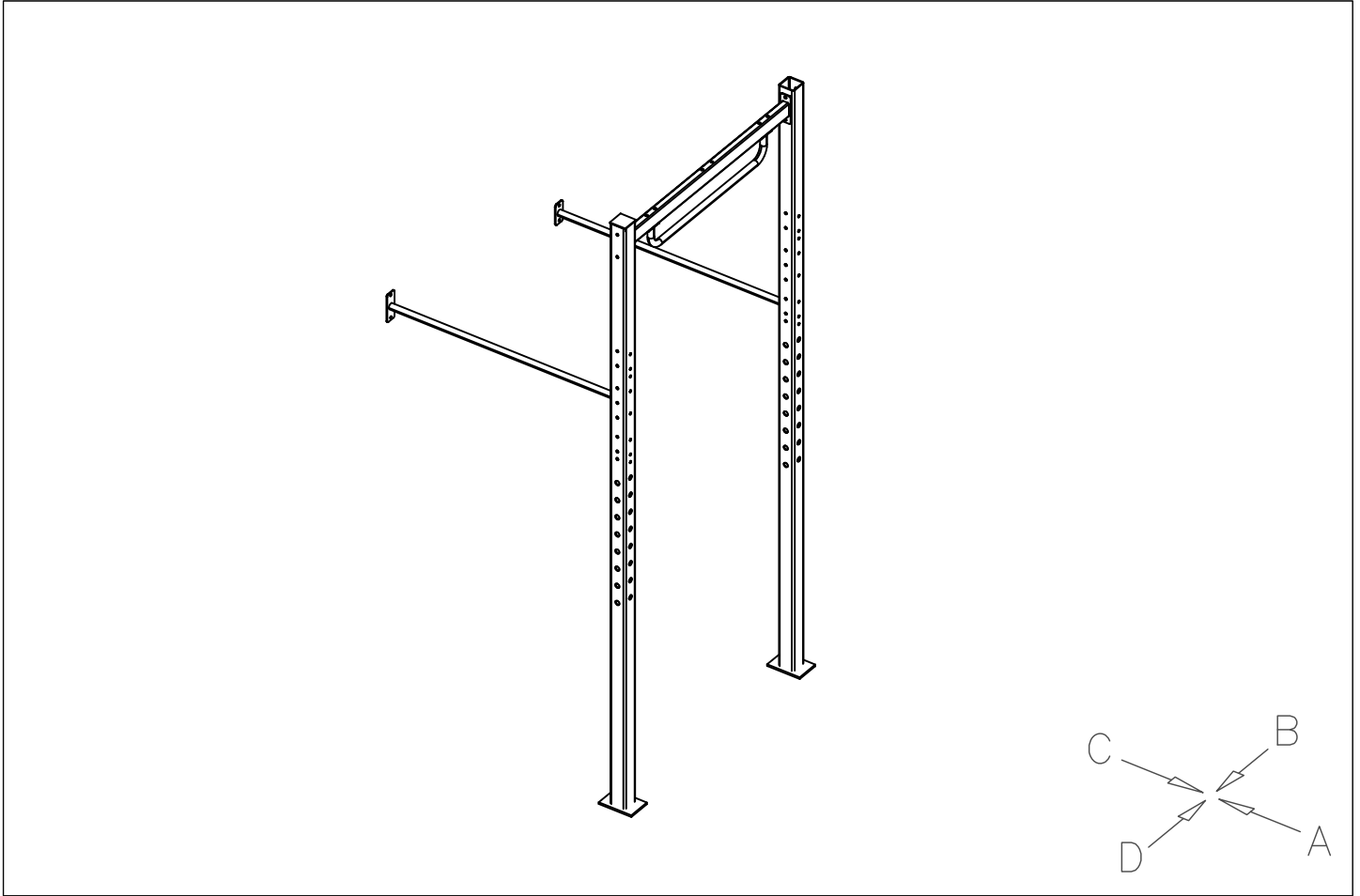

## FITNESS

DATE: 26.5.2020

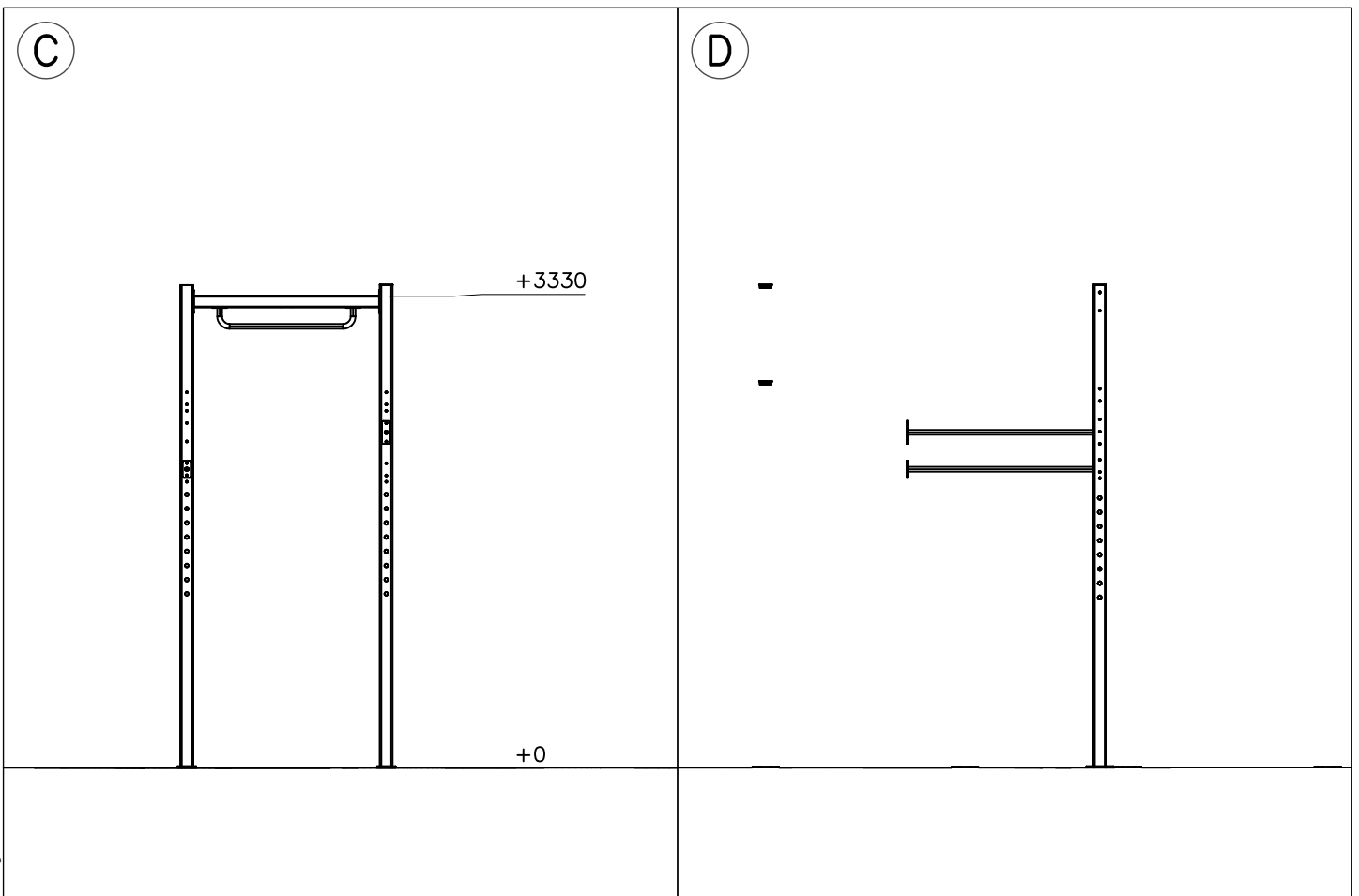
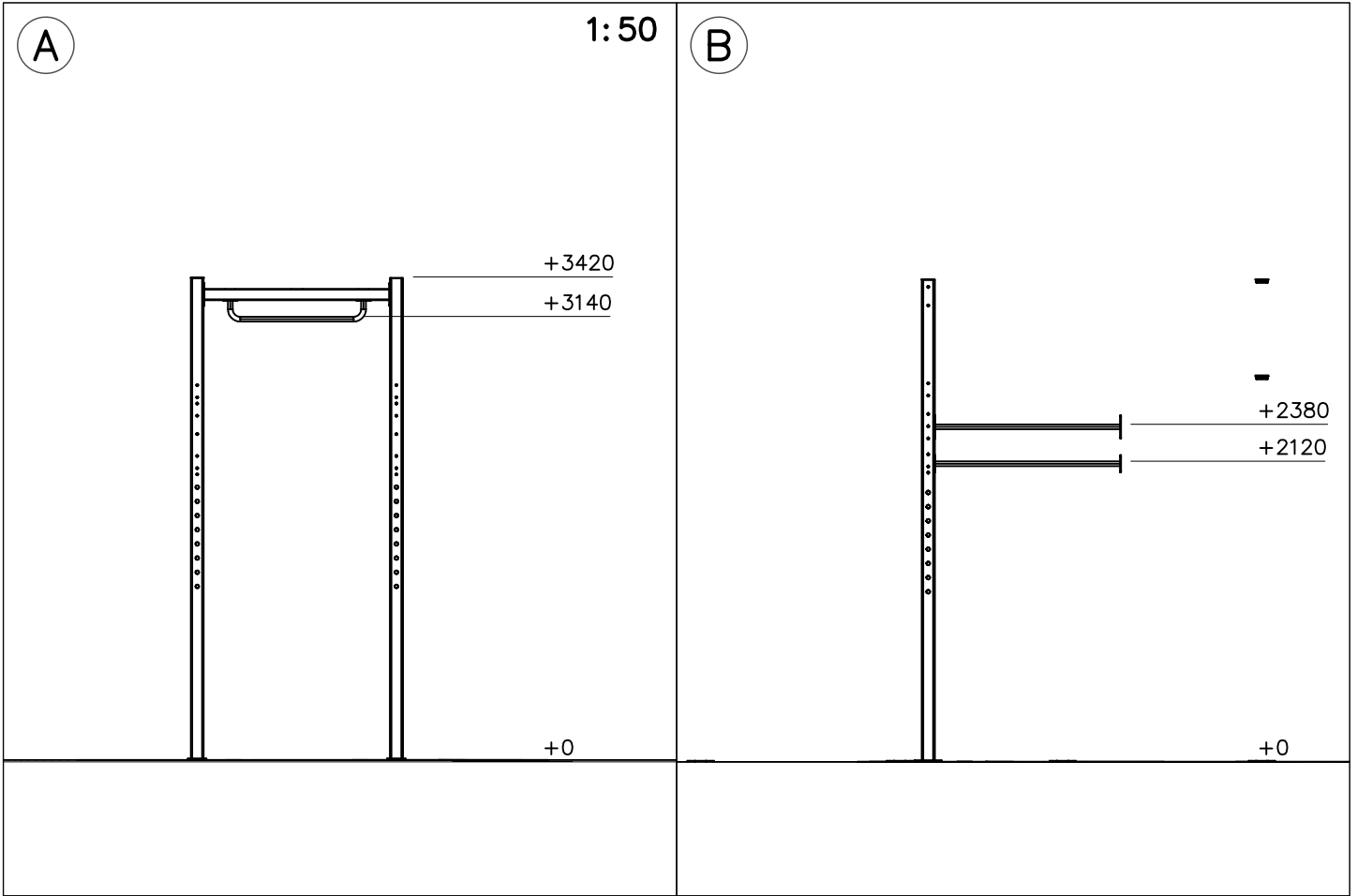

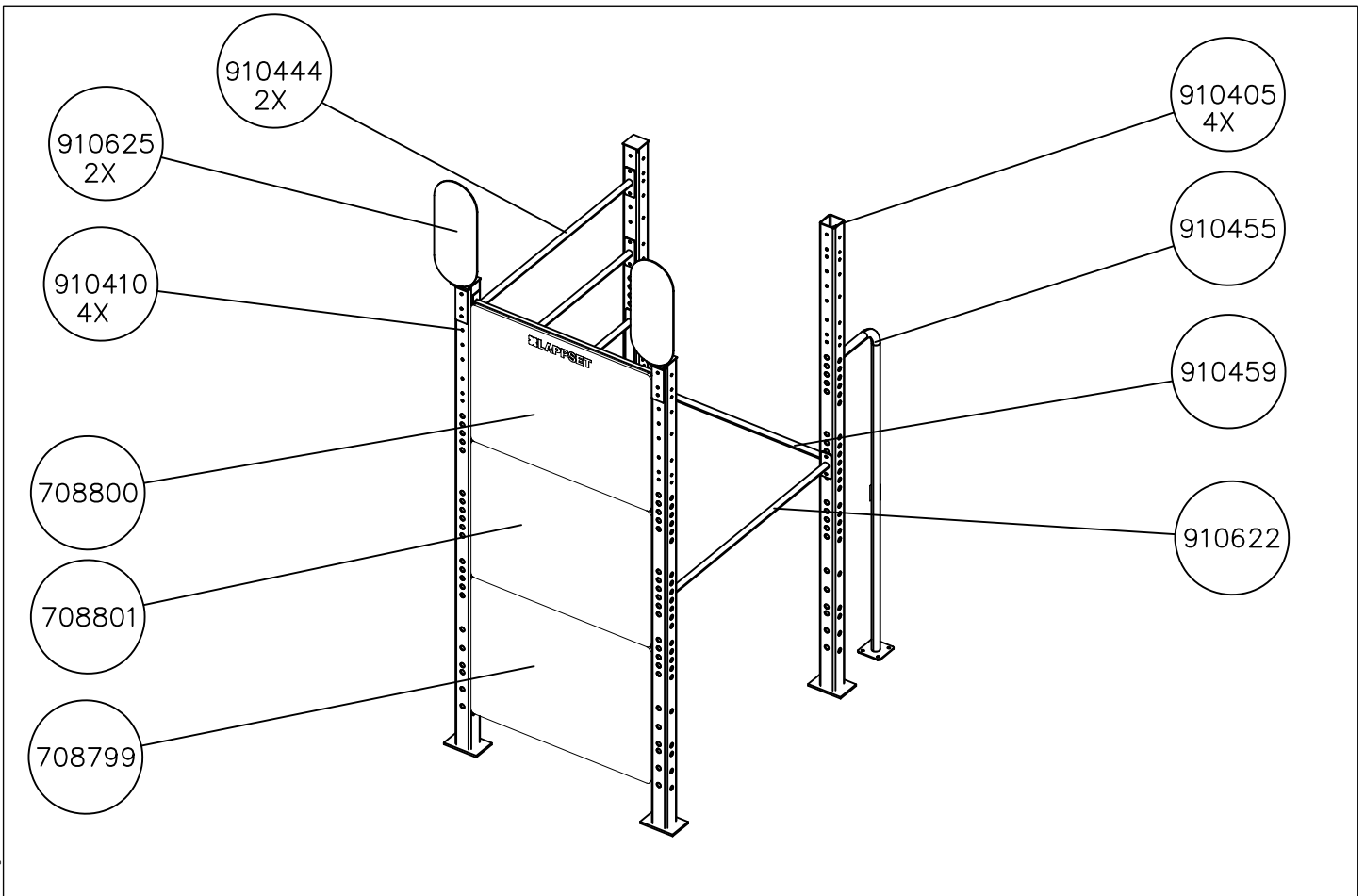
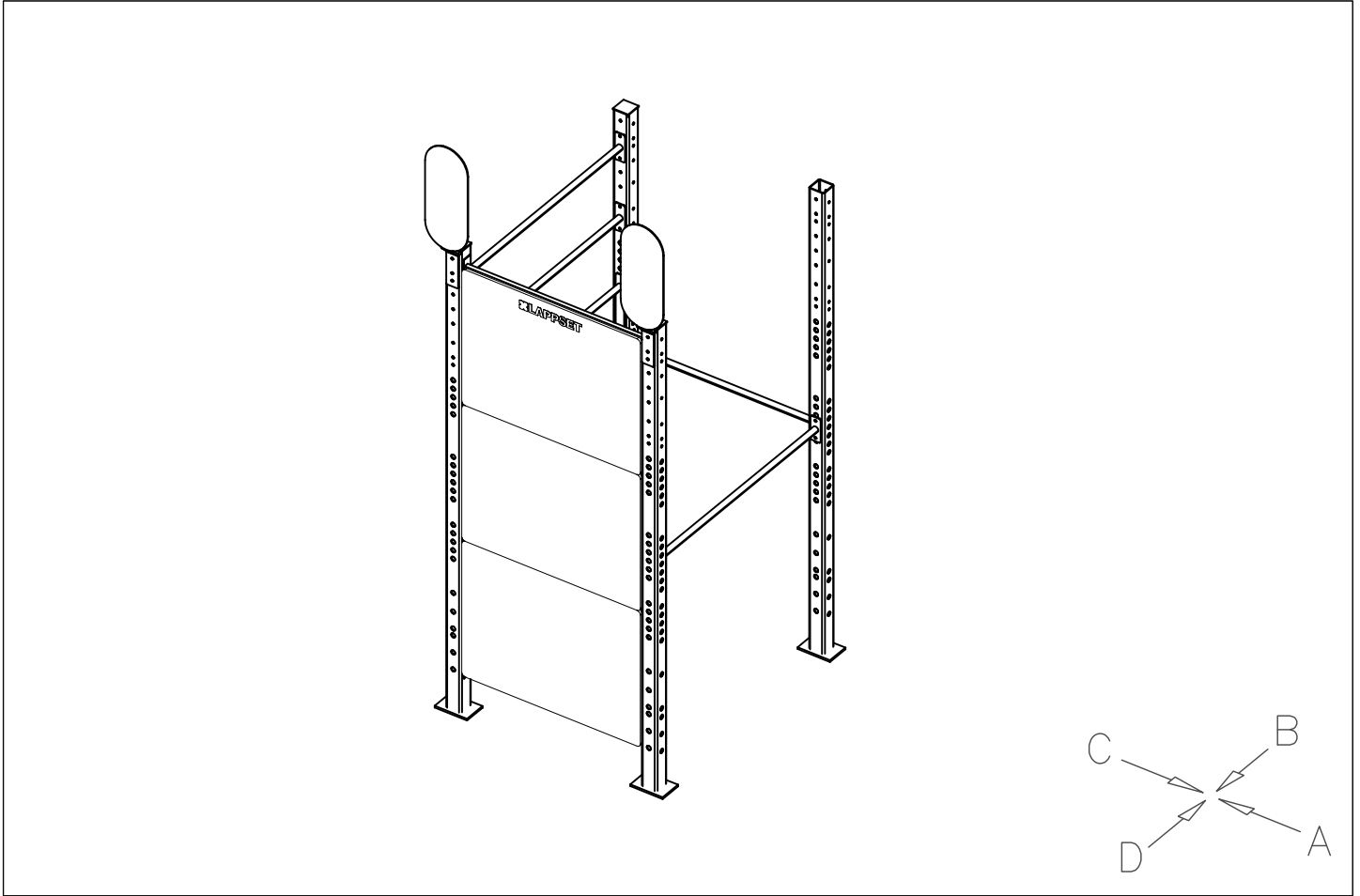

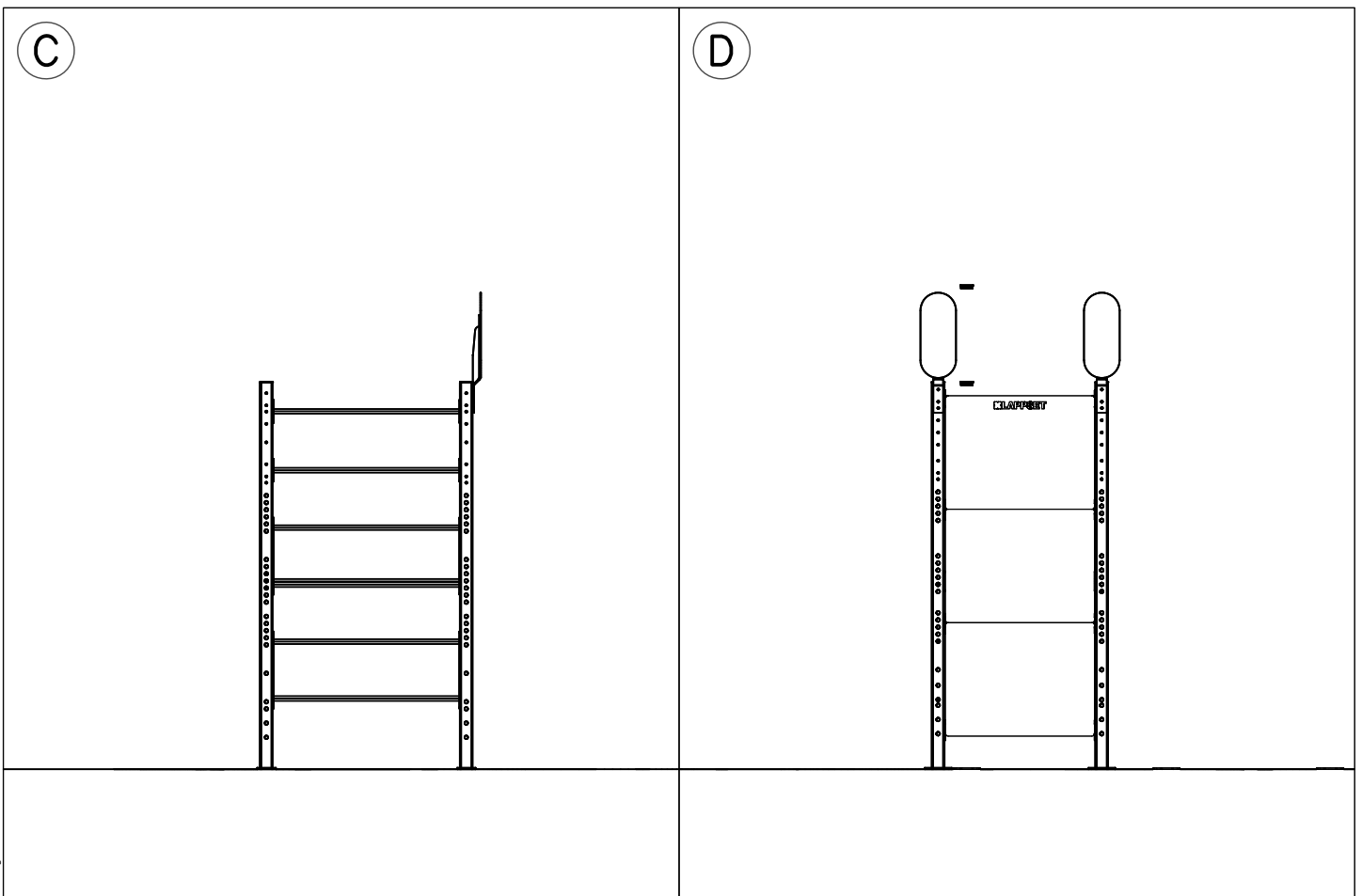
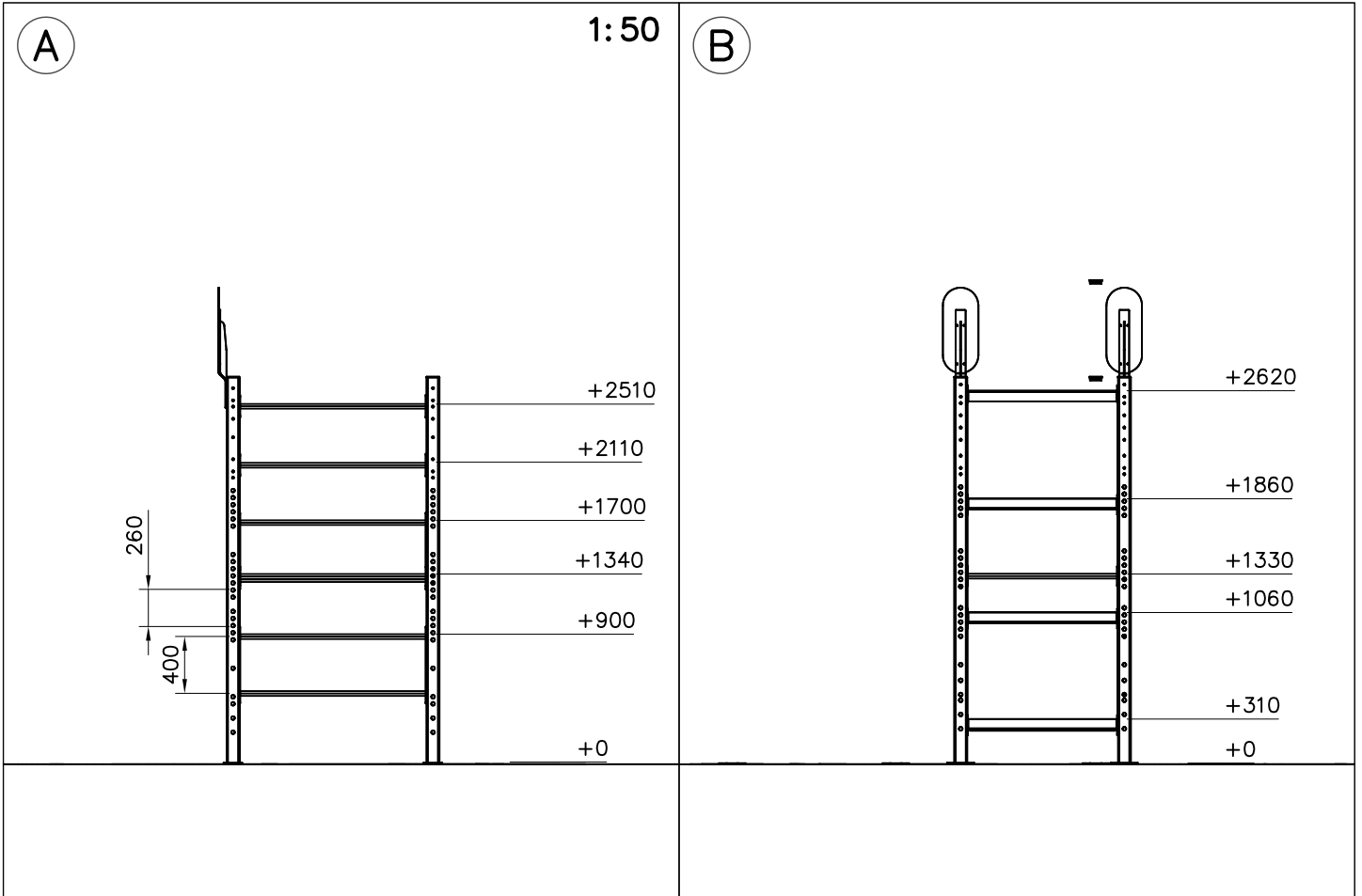

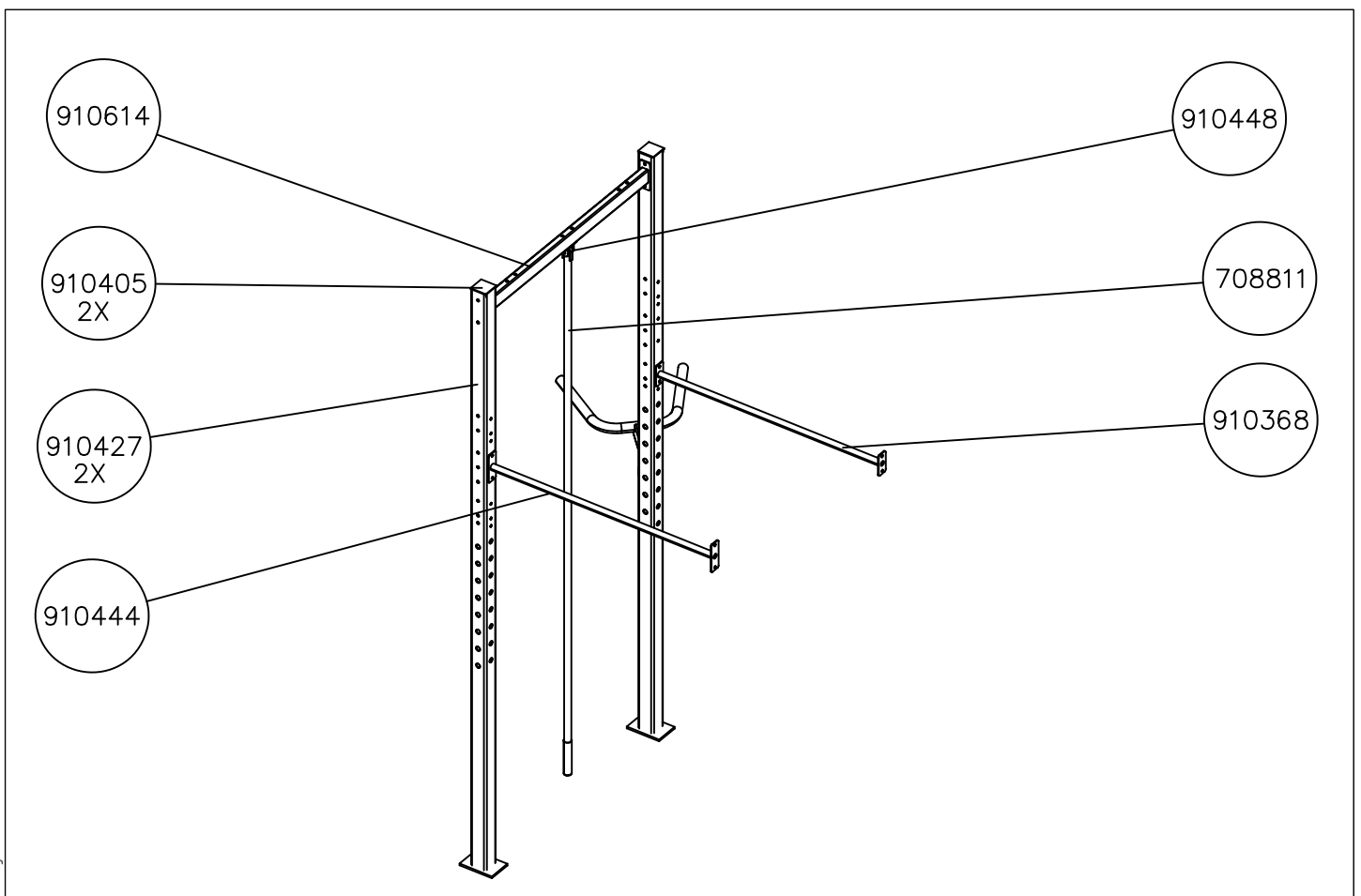
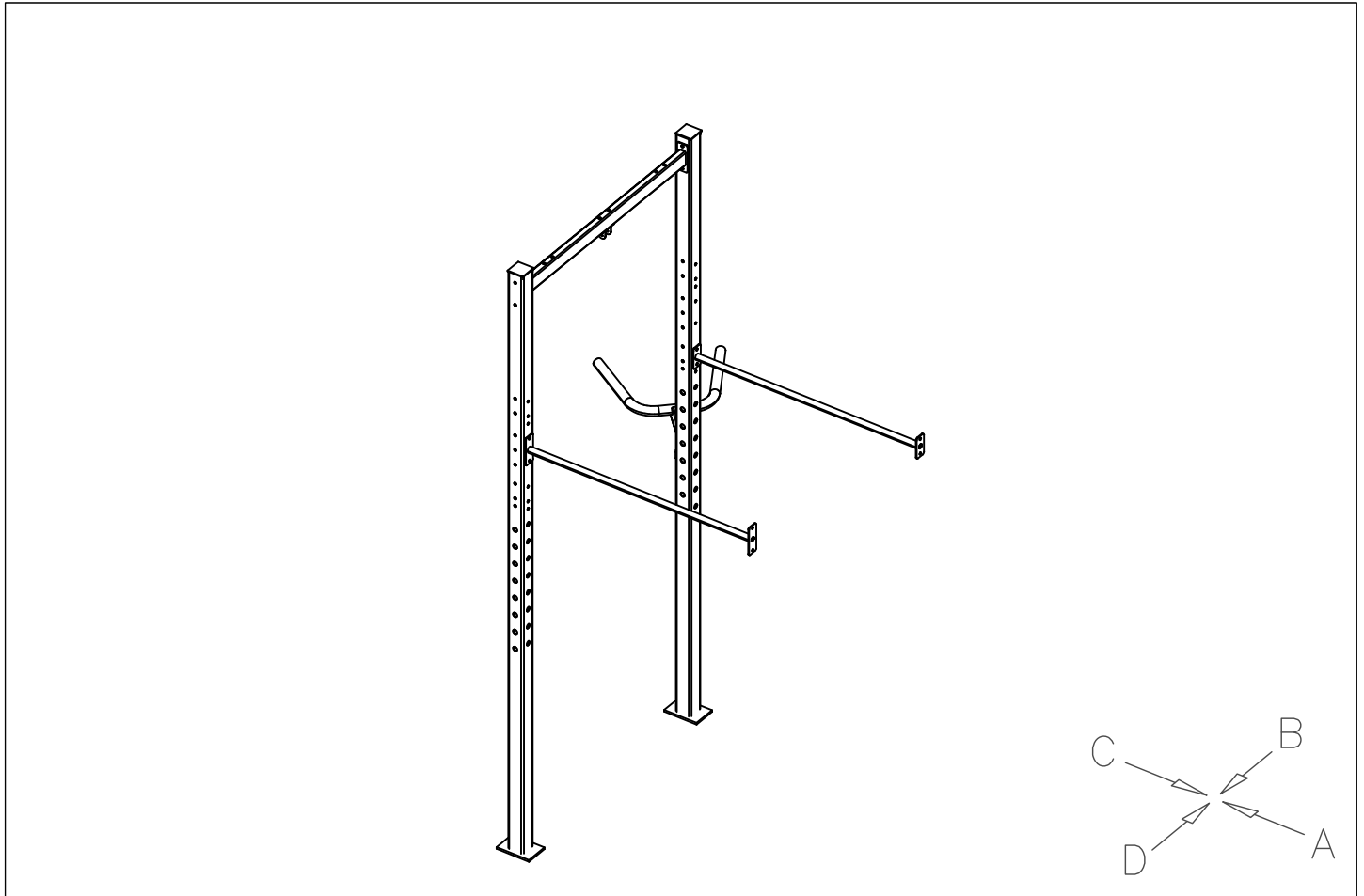

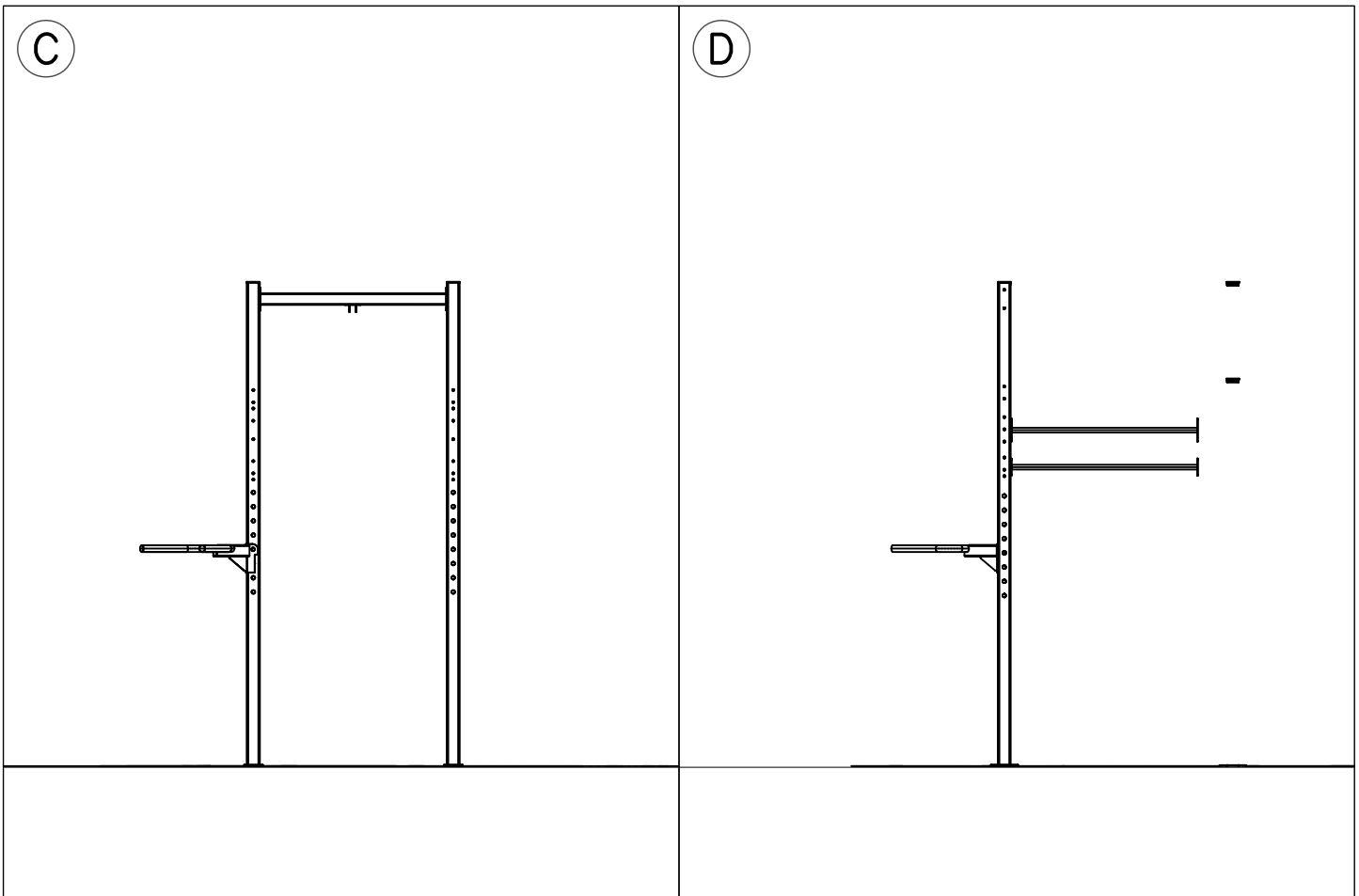
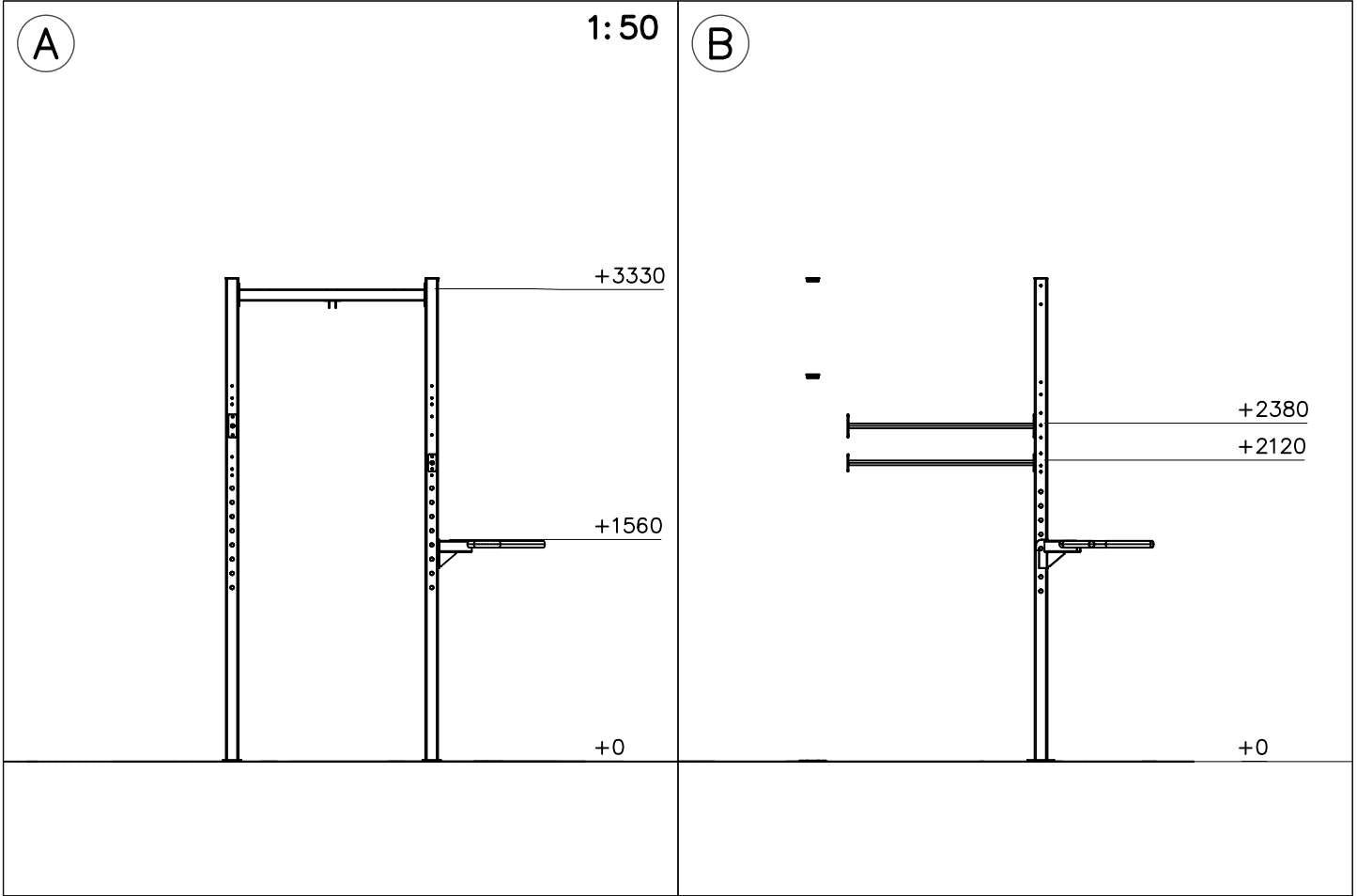

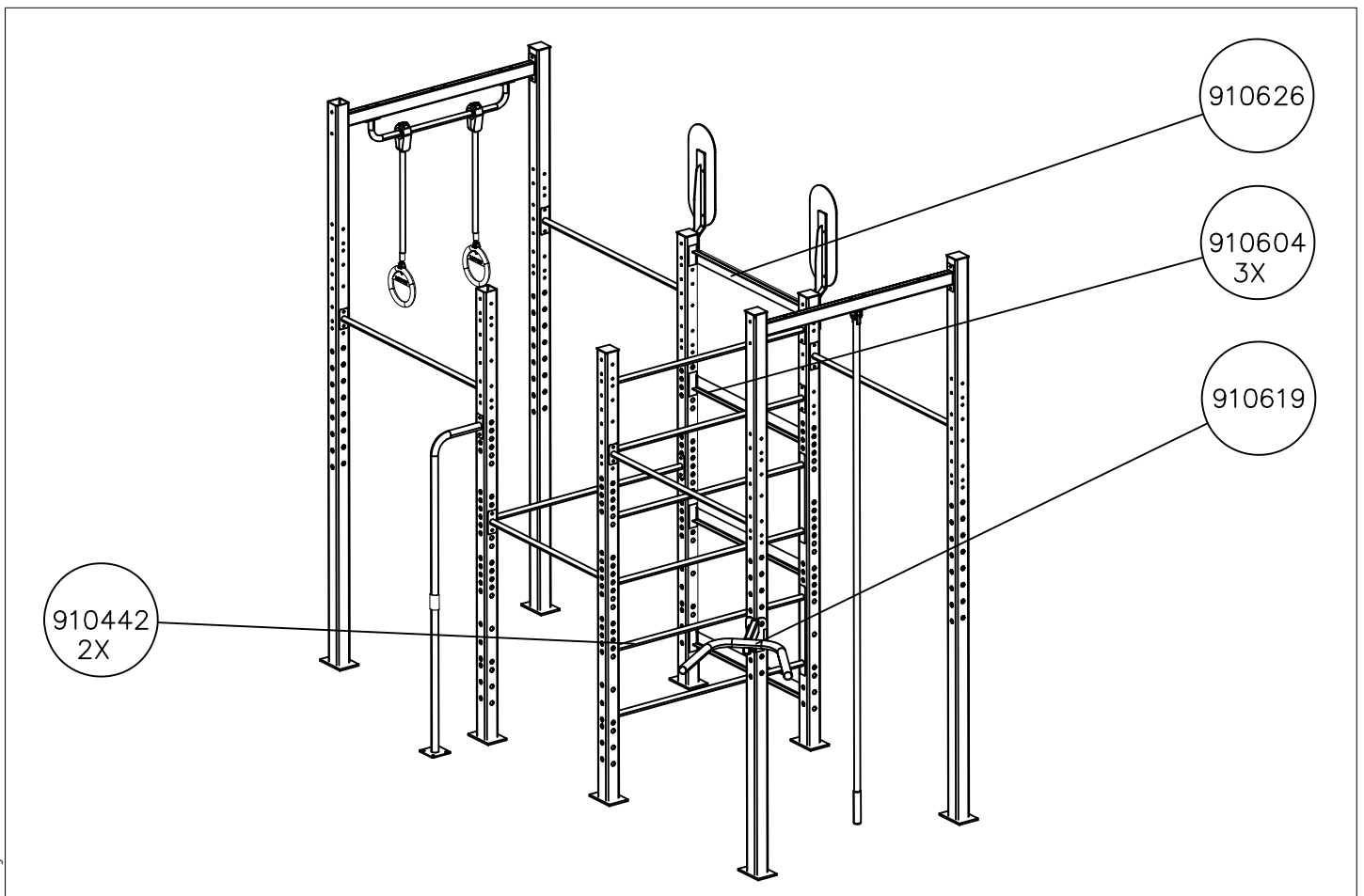
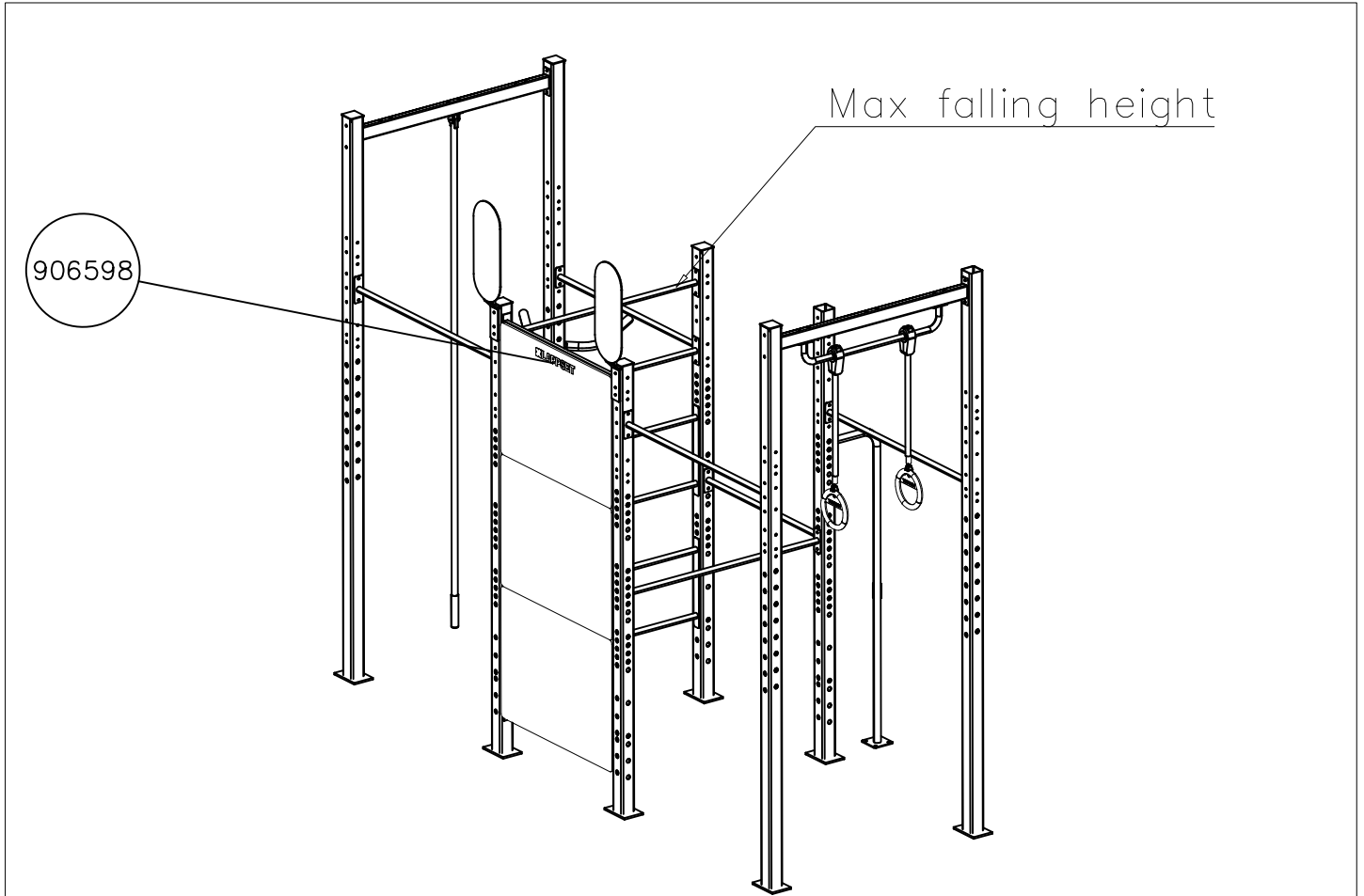

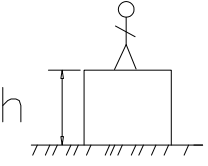
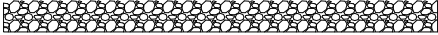

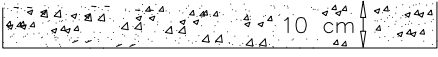
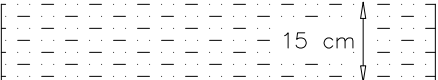

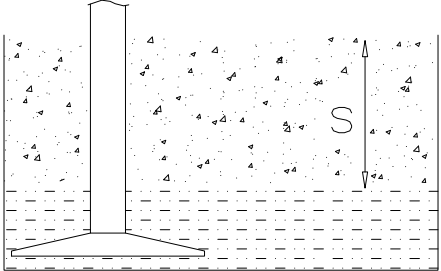
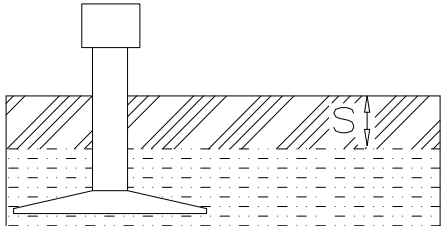
																		
<p><math>h &lt; 1000</math></p>	<p>Totally hard surfaces or materials with very limited impact attenuating properties.</p> <p>Case by case risk assessment is needed including e.g. evaluation whether there is forced movement, what is the intended exercise and where will the product be installed.</p>	<p>Totally hard surfaces. E.g. concrete or asphalt</p>  <p>Materials with very limited impact attenuating properties. E.g. wood</p> 																
<p><math>h &lt; 1200</math></p>	<p>Materials with significant impact attenuating properties.</p>	<p>fine gravel 0–8 mm</p>  <p>Unsorted sand/ topsoil</p> 																
<p><math>h &lt; 1500</math></p>	<p>Lawn</p> 																	
<p><math>h &lt; 3000</math></p>	<p>Loose fill material</p> <p>E.g. sand/gravel 0,25...8 mm D60/D10&lt;3,0 Woodchips 5...30 mm bark 20...80 mm</p>	 <table data-bbox="1011 1682 1321 1783"> <tr> <td><math>\underline{S}</math></td> <td><math>\underline{h}</math></td> </tr> <tr> <td>30 cm</td> <td>&lt; 2,0 m</td> </tr> <tr> <td>40 cm</td> <td>&lt; 3,0 m</td> </tr> </table> <p>Syntethic granulates</p> <table data-bbox="400 1883 746 2051"> <tr> <td><math>\underline{S}</math></td> <td><math>\underline{h}</math></td> </tr> <tr> <td>40 mm</td> <td>~&gt; 1,2...1,3 m</td> </tr> <tr> <td>50 mm</td> <td>~&gt; 1,5...1,7 m</td> </tr> <tr> <td>60 mm</td> <td>~&gt; 1,8...2,0 m</td> </tr> <tr> <td>70 mm</td> <td>~&gt; 2,1...2,5 m</td> </tr> </table> <p>Note. For accurate values, see manufacturer's instructions.</p> 	$\underline{S}$	$\underline{h}$	30 cm	< 2,0 m	40 cm	< 3,0 m	$\underline{S}$	$\underline{h}$	40 mm	~> 1,2...1,3 m	50 mm	~> 1,5...1,7 m	60 mm	~> 1,8...2,0 m	70 mm	~> 2,1...2,5 m
$\underline{S}$	$\underline{h}$																	
30 cm	< 2,0 m																	
40 cm	< 3,0 m																	
$\underline{S}$	$\underline{h}$																	
40 mm	~> 1,2...1,3 m																	
50 mm	~> 1,5...1,7 m																	
60 mm	~> 1,8...2,0 m																	
70 mm	~> 2,1...2,5 m																	



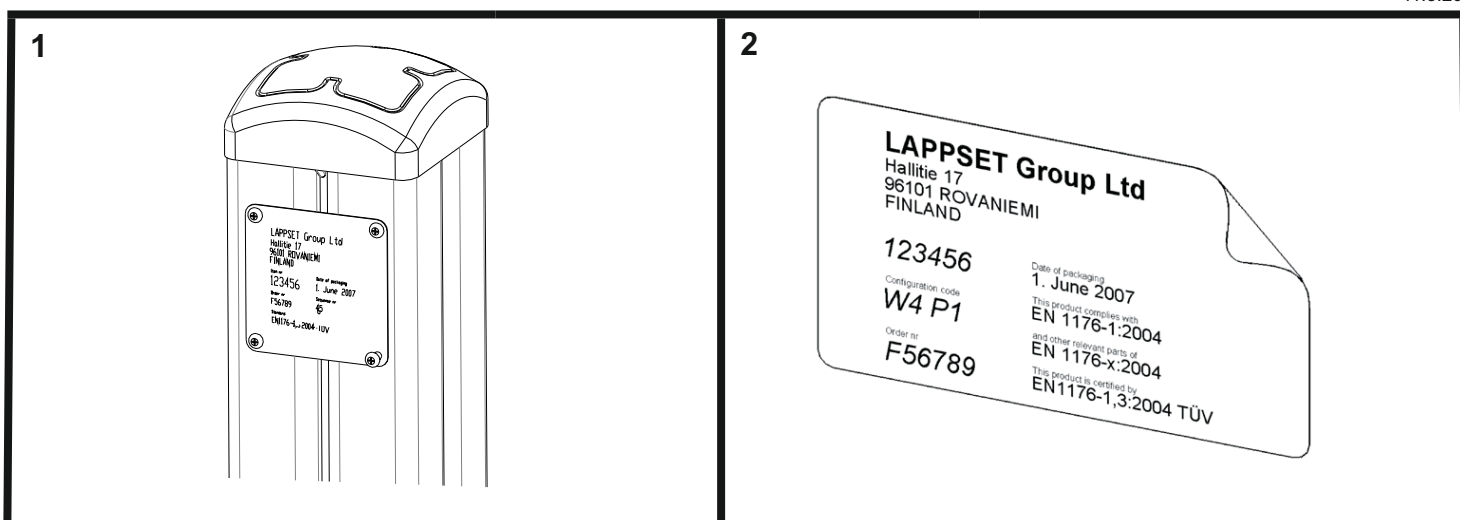

### Tuotekyltti tulee tuotteen mukana yhdellä seuraavista tavoista:

#### 1) Metallinen tuotekyltti ja kiinnitysruuvit

- Kiinnitä tuotekyltti ruuveilla tolppaan noin 2 metrin korkeuteen kuvan 2 mukaisesti.

#### 2) Tuotekyltitarra

- Puhdista maalattu metalli- tai vaneripinta pölystä ja kosteudesta. Liimaa tarra kuvan 3 mukaisesti.
- Huom. Älä kiinnitä tarraa karheapintaiseen laminaattiin tai maalattuun puuhun.

### Vår produktmärkning levereras på ett av följande sätt:

#### 1) Produktskylt i metall

- Fäst skylten med de medföljande skruvarna

#### 2) Självhäftande produktetikett

- Rengör den pulverlackerade metallytan eller laminatytans åttanblirfrifrån smuts och fukt. Fäst etiketten enligt fig. 3.
- Obs! Fäst ej etiketten på detaljer med skrovlig yta eller på målat trä.

### Product label is delivered by one of following ways:

#### 1) Metal product label and screws

- Fasten the label with screws.

#### 2) Label sticker

- Clean the painted metal or plywood surface from dirt and moisture. Fasten the sticker as shown in the figure 3.
- Note. Do not attach the sticker to rough surfaced laminate or painted wood.

### La plaque d'informations produit est livrée sous l'une de ces 3 formes :

#### 1) Plaque métallique et vis

- Fixez la plaque à l'aide des vis.

#### 2) Etiquette autocollante

- Avant de coller l'étiquette, nettoyez le composant métallique peint ou la plaque de contreplaqué, de toute saleté. La surface doit être sèche (voir image 3).
- Attention, ne pas coller l'étiquette sur une surface lamellé-collée irrégulière ou sur du bois peint.

### Die Auslieferung des Produktaufklebers erfolgt auf eine dieser Arten:

#### 1) Produkt-Schild aus Metall incl. Schrauben

- Die Befestigung des Schildes erfolgt mittels der Schrauben.

#### 2) Aufkleber

- Entfernen Sie zunächst Schmutz und Feuchtigkeit vom lackierten Metall bzw. von der Holzoberfläche und bringen Sie den Aufkleber wie im Bild oben rechts beschrieben auf den gesäuberten Untergrund auf.
- Beachten Sie: Bringen Sie den Aufkleber nicht auf raues laminiertes oder lackiertes Holz an.