

DET 1

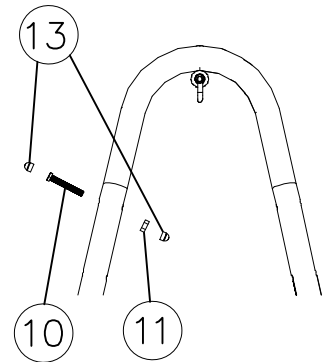

DET 2

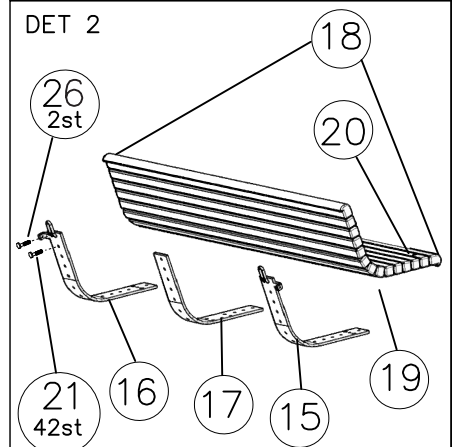

DET 3

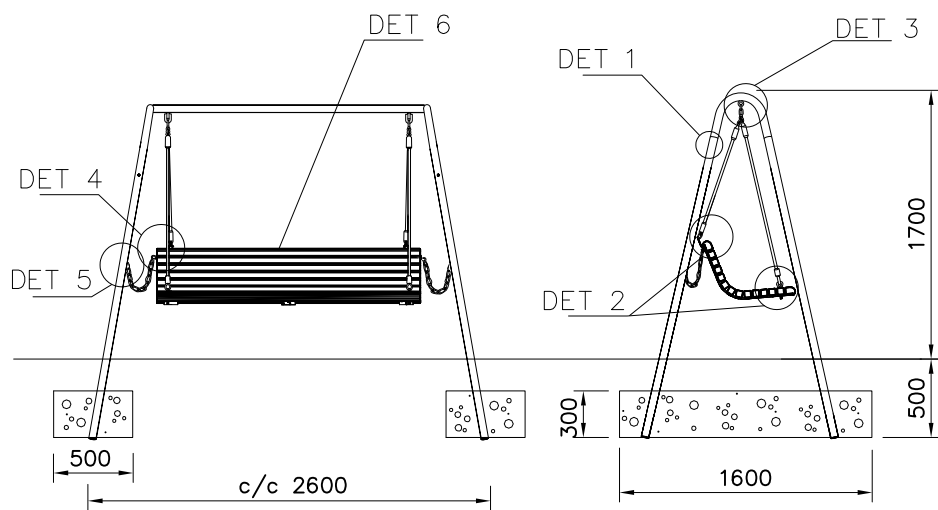
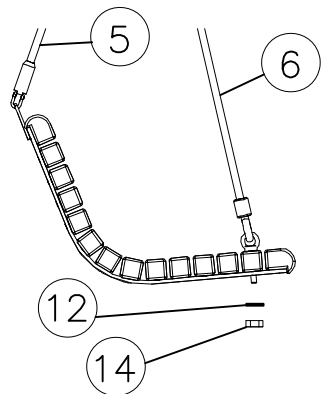

DET 4

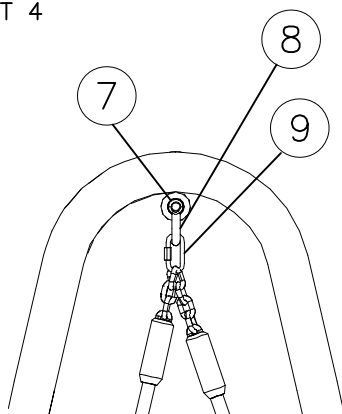



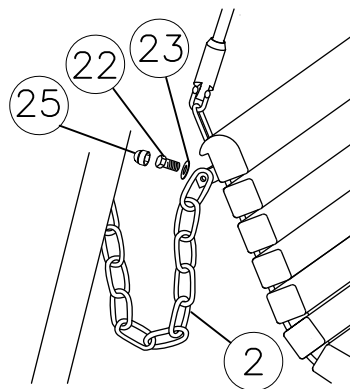



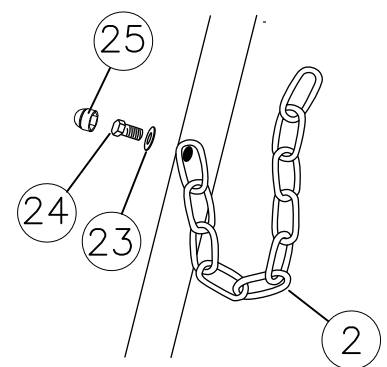

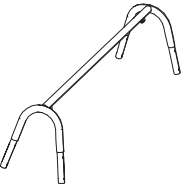





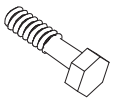

DET 5

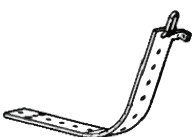
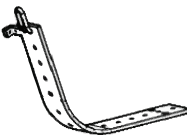
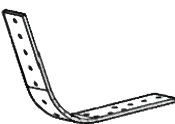
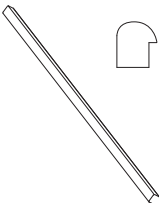
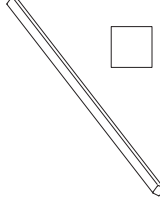
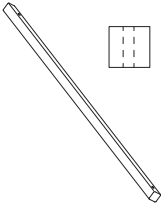
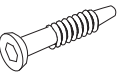

DET 6

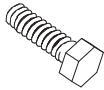

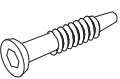
<p>① N902589</p>  <p>PCS/ST 1</p>	<p>② N00176</p>  <p>PCS/ST 2</p>	<p>③ N213123</p>  <p>PCS/ST 2</p>	<p>④ N213124</p>  <p>PCS/ST 2</p>	<p>⑤ 702440</p>  <p>L=675</p> <p>PCS/ST 2</p>
<p>⑥ 702441</p>  <p>L=970</p> <p>PCS/ST 2</p>	<p>⑦ 902599</p>  <p>PCS/ST 2</p>	<p>⑧ N00156</p>  <p>M10</p> <p>PCS/ST 2</p>	<p>⑨ N00155</p>  <p>M6</p> <p>PCS/ST 2</p>	<p>⑩ 902593</p>  <p>M10X60</p> <p>PCS/ST 8</p>
<p>⑪ 909637</p>  <p>M10</p> <p>PCS/ST 8</p>	<p>⑫ 980154</p>  <p>13X24X2.5</p> <p>PCS/ST 2</p>	<p>⑬ 905104</p>  <p>M10</p> <p>PCS/ST 16</p>	<p>⑭ 909248</p>  <p>M12</p> <p>PCS/ST 2</p>	<p>⑮ N213121</p>  <p>PCS/ST 1</p>
<p>⑯ N213122</p>  <p>PCS/ST 1</p>	<p>⑰ N902700</p>  <p>PCS/ST 1</p>	<p>⑱ N702411</p>  <p>PCS/ST 2</p>	<p>⑲ N702410</p>  <p>PCS/ST 11</p>	<p>⑳ N702412</p>  <p>PCS/ST 1</p>
<p>㉑ N00109</p>  <p>7X30</p> <p>PCS/ST 42</p>	<p>㉒ N01920</p>  <p>M8X20</p> <p>PCS/ST 2</p>	<p>㉓ N13818</p>  <p>18X9X1.5</p> <p>PCS/ST 4</p>	<p>㉔ N01930</p>  <p>M8X30</p> <p>PCS/ST 2</p>	<p>㉕ 902607</p>  <p>M8</p> <p>PCS/ST 4</p>
<p>㉖ N00189</p>  <p>7X35</p> <p>PCS/ST 2</p>				