

| | | | |
|---|-----|---|-----|
| ○ 977210 | PCS | ○ 977220 | PCS |
|  | |  | |
| RED | | BLACK | |
| ○ 977230 | PCS | ○ 977240 | PCS |
|  | |  | |
| GREY | | GREEN | |
| ○ 977250 | PCS | ○ 977260 | PCS |
|  | |  | |
| EPDM1 | | EPDM2 | |
| ○ 977310 | PCS | ○ 977320 | PCS |
|  | |  | |
| RED | | BLACK | |
| ○ 977330 | PCS | ○ 977340 | PCS |
|  | |  | |
| GREY | | GREEN | |
| ○ 977350 | PCS | ○ 977360 | PCS |
|  | |  | |
| EPDM1 | | EPDM2 | |

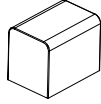
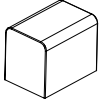
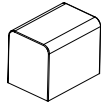
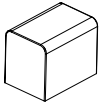
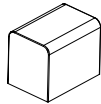
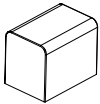
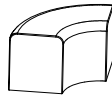
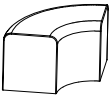
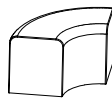
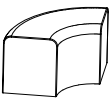
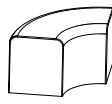
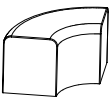
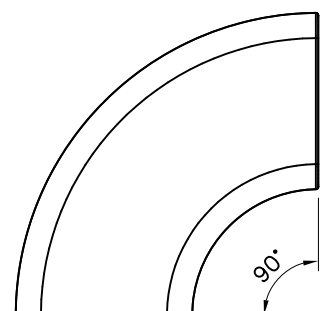

STRAIGHT/CURVED

All products are with **surface mounting as default.**

- The sub-base must be even.
- The product can be glued onto the type of ground where adherence is possible, without any special parts.

Optional deep mounting:

- 2 Holes on the bottom of the straight block and curve block.
- 2 Installation pipes will be added. One end to the product and the other end into a concrete foundation
- Ground anchor (977002), tube $\text{Ø}42,8\text{mm} \times 300\text{mm}$

