

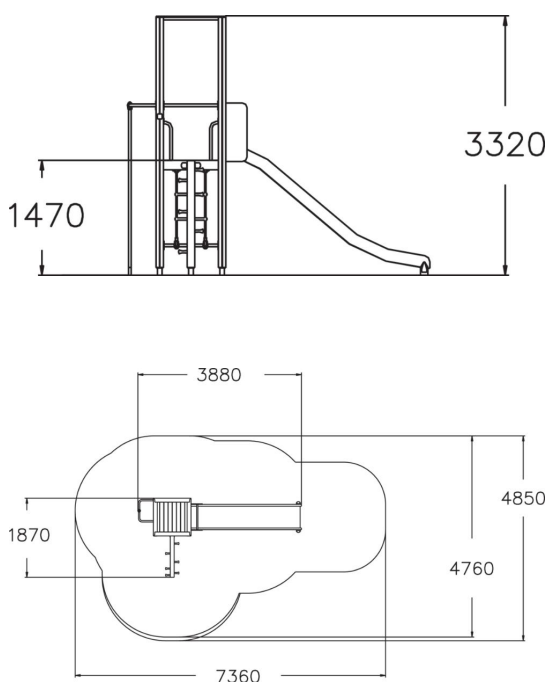

-  Climbing
2
-  Roofs
1
-  Slides
1
-  Towers
1



The high (1,470 mm) tower can be accessed by the curved ladder or rung ladder, and the exhilarating descent at high speed is via the slide or a fireman's pole.



User age	4+
Number of users	5
Product length, mm	1880
Product width, mm	3880
Product height, mm	3320
Impact area, m ²	25
Falling space, m ²	25.3
Height required, mm	3320
Max. free fall height, mm	1470
Safety info	EN 1176-1, 3 TÜV
Installation time (for 1), H	7
Foundation options	Deep mounting Surface mounting