

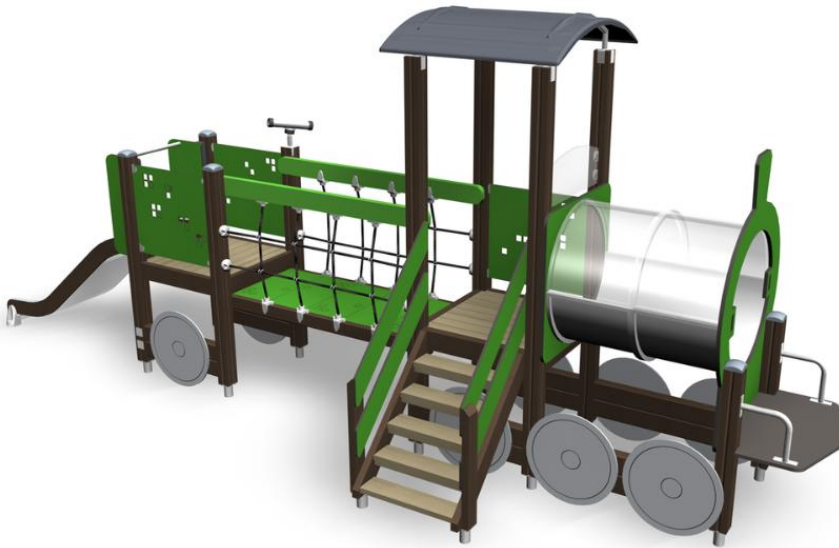





WINAM GROUP

137935

Train



-  Bridges
1
-  Climbing
1
-  Roofs
1
-  Slides
1
-  Towers
2

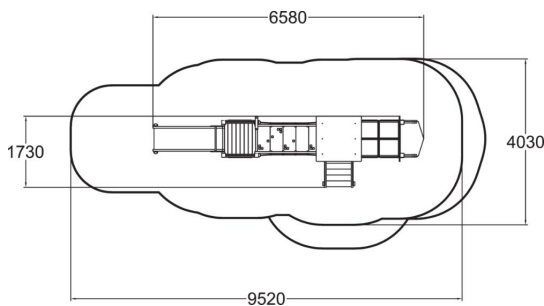
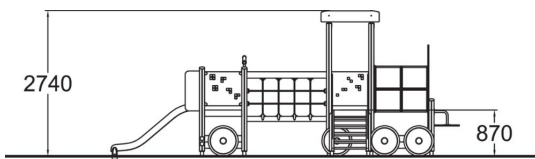

User age	2+
Number of users	10
Product length, mm	6580
Product width, mm	1730
Product height, mm	2740
Impact area, m ²	32.2
Falling space, m ²	35.6
Height required, mm	2740
Max. free fall height, mm	1000
Safety info	EN 1176-1, 3 TÜV
Installation time (for 1), H	23
Foundation options	Deep mounting
Colour of walls and HPL	