

The Vault Cage can be used for practising vault series, underbars and jumps. The bars placed at different heights provide a challenge. The total height is 1500 mm. The Cloxx Parkour products conform to the European Standard for Playground equipment EN 1176, so they are suitable for schoolyards and playgrounds.

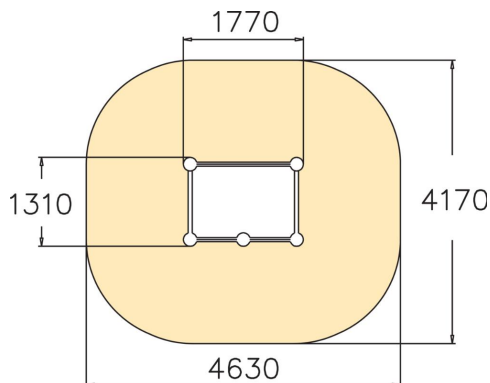
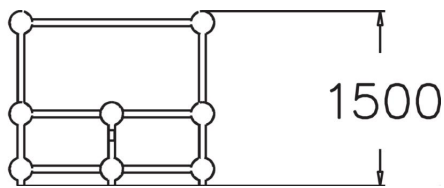

User age	6
Number of users	5
Product length, mm	1770
Product width, mm	1310
Product height, mm	1500
Impact area, m <sup>2</sup>	17.2
Falling space, m <sup>2</sup>	17.2
Height required, mm	2450
Max. free fall height, mm	1430
Safety info	EN 1176-1 TÜV
Installation time (for 1), H	7
Foundation options	Deep mounting Surface mounting